

IKEUCHI Spray nozzles for the Iron & Steel Industry

17S



High quality spray nozzles supporting the

Steel is an essential product in our lives.

Leading-edge technologies and know-how are required to produce the highest-quality, highest-performance steel products.

IKEUCHI helps steelmakers manufacture uniformly high quality products, create effective and cost-saving production lines, as well as ensure reliable, stable operation.

IKEUCHI has developed spray nozzles and systems for steel cooling, energy-saving descaling, and many other applications.

We will continue our efforts and development to meet all of our customers' needs.

Classification of Spray Droplet Size

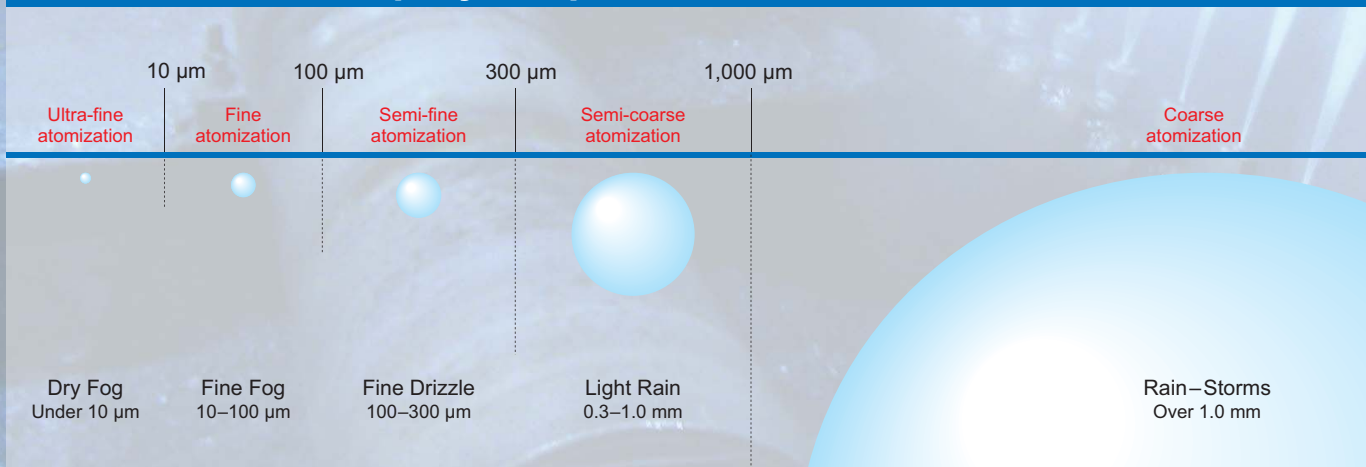

There are many opinions on the classification of spray droplet sizes but IKEUCHI, "The Fog Engineers", have classified them as above and propose optimized fog for specific requirements and work-environment conditions.

steelmaking industry worldwide

Contents

		Pages
	Classification of Spray Droplet Size 1
	Contents 2
	IKEUCHI Cooling Technology: 3
	Cooling effects and conditions, Guarantee of precision nozzle performance	
	Cooling technology 4
	Fog spray cooling systems, Profile of supporting data 5
	Nozzle applications for each process: 6
	Raw material & iron making process	
	Steel making process 7
	Plate mill/ Hot rolling mill/ Cold rolling mill 8
	Surface finish, other processes 9
	Spray Nozzle Materials 10
	How to Read the Tables 11
Descaling nozzles	TDSS series	Descaling Nozzles 12
Brush-cleaning nozzle header	BRASIKan® series	Manual Brush-cleaning Nozzle Header 15
	Air-driven BRASIKan® series	Air-driven Automatic Brush-cleaning Nozzle Header 16
Pneumatic spray nozzles	DOVEA series	Flat Spray Nozzles with Even Distribution 17
	DOVEA-W series	Flat Spray Nozzles -Wider Spray Thickness- 18
	DDA series	Ultra-Thick Flat Spray Nozzles 19
	DDRP+AS series	Hydraulic/Pneumatic (Dual-use) Ultra-Thick Even Flat Spray Nozzles 21
	VVP+AS series	Hydraulic/Pneumatic (Dual-use) Flat Spray Nozzles 23
	BIM series	Small Capacity Fine Fog Nozzles 24
	BIM Header	Integrated Spray Header with BIM Fine Fog Nozzles 27
	GSIMII series	Large Capacity Fine Fog Nozzles 29
	VVEA series	High Impact Flat Spray Semi-fine/Semi-coarse Fog Nozzles 34
	YYA series	Wide-angle Flat Spray Pneumatic Spray Nozzles 36
	BAVV series	Blower-air Driven Flat Spray Fine Fog Nozzles 37
	VVP series	Standard Flat Spray Nozzles 39
	WVVP series	Thick Flat Spray Nozzles 43
	VVEP series	Even Flat Spray Nozzles 44
	WVVEP series	Thick Flat Spray Nozzles with Even Distribution 45
	EJVV series	Air Mixing Type Flat Spray Nozzles 46
	DDRP series	Ultra-Thick Flat Spray Nozzles with Even Distribution 47
	Spray Nozzle Lineup for Cast Steel Cooling 48
	VV+YY series	Dual Flat Spray Nozzles 49
	OVVEP series	Off-center Flat Spray Nozzles with Even Distribution 50
	WOVVEP series	Off-center Thick Even Flat Spray Nozzles 50
	MOMOJet® series	Self-cleaning Flat Spray Nozzles 51
	INVV series	Quick-detachable Standard Flat Spray Nozzles 52
	JJXP series	Standard Full Cone Spray Nozzles 54
Hydraulic spray nozzles	AJP series	Clog-resistant Vaneless Full Cone Spray Nozzles 56
	Wide-angle AJP series	Clog-resistant Wide-angle Full Cone Spray Nozzles 57
	TAA series	Wear-resistant Large Capacity Hollow Cone Spray Nozzles (Flange type) 58
	TWAA series	Wear-resistant Bi-directional Hollow Cone Spray Nozzles (Flange type) 58
	JUXP series	Wear-resistant Full Cone Spray Nozzles 58
	BBXP series	Wide-angle Full Cone Spray Nozzles 59
	SSXP series	Square Full Cone Spray Nozzles 61
	TJJX series	Flange Type Full Cone Spray Nozzles 62
	7JJXP series	7-head Full Cone Spray Nozzles 63
	SPB series	SPILLBACK Nozzle with Variable Flow 64
	KKK series	Hollow Cone Spray Nozzles w/ Variable Spray Angle & Spray Capacity 65
	3OV series	3-Head Off-center Flat Spray Nozzles 65
	CMP-Sa series	Solid Stream Jet with Wear-resistant Sapphire Orifice 66
	TAIFUJet® series	Air Booster Nozzles 67
		SLNH-H/SLNHA-H series
Slit nozzles	SLNB series	Slit Nozzles Utilizing Blower Air 70
	LLYOH series	Blower LYOHM Header 71
	PSN series	Pneumatic Slit Nozzles 71
Accessories (Special fittings)	UT series	Universal Ball Joints 72
	WUT series	360° Rotatable Universal Joints 73
Rotating nozzles	RJ series	Low-pressure Rotating Cleaning Nozzles 74
	JA series	Rotating Nozzles for Tank Cleaning 74
	SR series	Low-Speed Rotating Cleaning Nozzles 75
	ES series	Rotating Cleaning Nozzles for Tanks/Containers 75
Nozzle-related unit products	CLJ series	Cooling Fan Unit with Semi-Dry Fog® Nozzles 76
	ARS series	Auto Reverse Self-cleaning Filter 78

Specifications of the products and contents of this catalog are subject to change without prior notice for purpose of product improvement.

IKEUCHI Cooling Technology

IKEUCHI provides high-quality spray nozzles and control systems, CFD simulation analysis, and cooling trial experiments combined with an outstanding performance record for the steel industry.

Cooling effects and conditions

- The effect of spray cooling is dependent on *the fog, the cooling target, the environment and the cooling medium.*
- IKEUCHI measures each aspect of fog spraying performance and uses CFD simulation to create plans for the optimum cooling conditions.

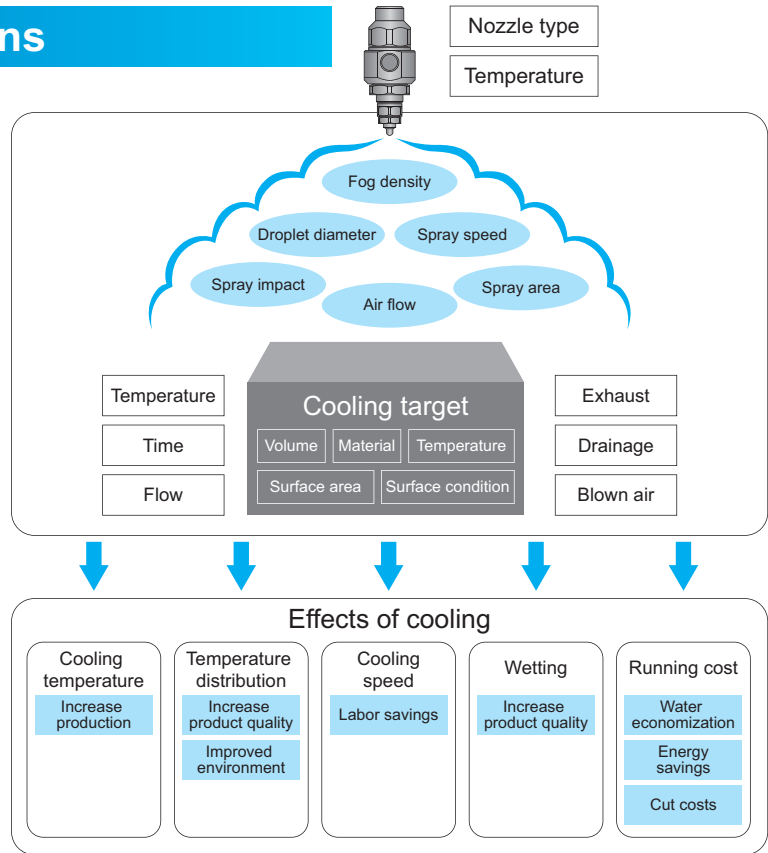

Guarantee of precision nozzle performance

To produce the best cooling effects, all spray nozzles must provide uniform spray performance as designed.

All IKEUCHI's precision-made hydraulic spray nozzles are guaranteed for spray angles and spray capacities. This guarantee covers metal, plastic, and ceramic nozzles.

Spray Capacity Tolerance	Spray Angle Tolerance	Spray Angle Tolerance for Solid Stream Jet
<p>+/- 5%</p> <p>Guaranteed to within +/- 5% of the rated spray capacity under the standard pressure.</p>	<p>+/- 5°</p> <p>Guaranteed to within +/- 5 degrees of the rated spray angle under the standard pressure. Spray angle is the angle of spray measured near the nozzle, unless otherwise specified.</p>	<p>Within 3°</p> <p>Solid stream jet nozzles are guaranteed for the axis of spray direction within 3 degrees from the nozzle body centerline under the standard pressure.</p>

A standard pressure is defined as the design pressure based on the common liquid pressure during normal use for each hydraulic spray nozzle series. Nozzles are designed to provide the specified spray capacity, spray angle, optimal spray pattern (cross sectional shape of the spray) and spray distribution at each standard pressure. IKEUCHI sets an original inspection standard for the spray pattern, too.

Each pneumatic spray nozzle series also has spray capacity inspection standard at each standard pressure. Only the nozzles that pass the inspection will be shipped.

Note:
 1) The figures in this catalog are based on tap water at room temperature and the liquid pressure is measured at the immediate upstream of the nozzle.
 2) The above guarantee does not cover air nozzles. Air consumption (blowing air volume) shown in this catalog is for reference only.

Cooling technology

Slab cooling

For cooling of hot slabs, strong impact force is needed to break through the film boiling.

Through cooling trial experiments, we can provide the optimum nozzles and layout.

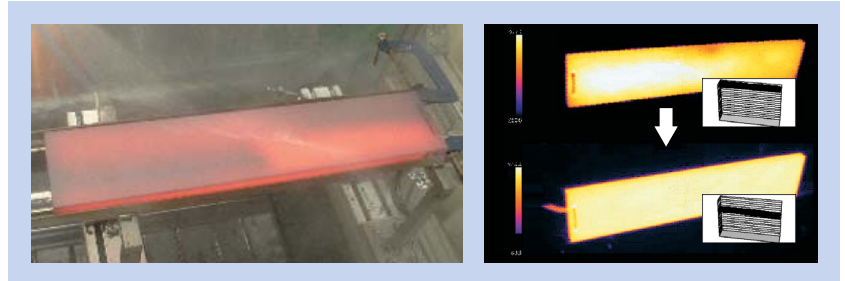

Thin slab cooling

Cooling for surface finishing of steel slabs requires a large amount of fine fog to produce a smooth surface texture. IKEUCHI has been developing low-energy atomizing nozzle units.

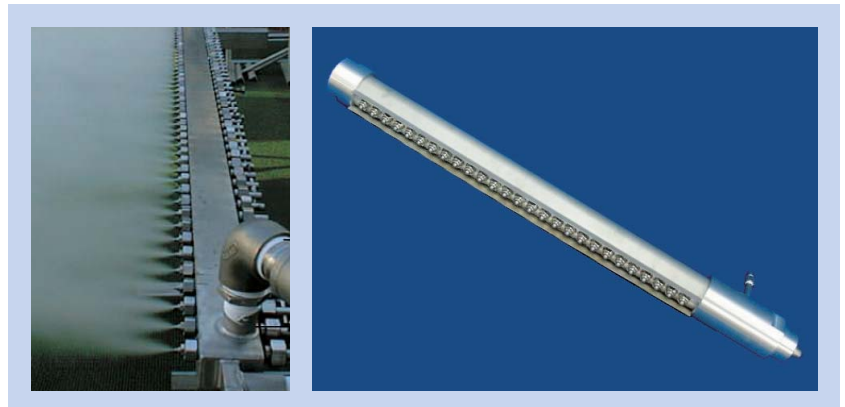

Flue gas cooling

Cooling of high temperature flue gas such as sintering exhaust requires spray control and droplet diameters that yield complete evaporation.

IKEUCHI uses CFD simulation when selecting the control system and nozzles that can provide completely evaporating spray.

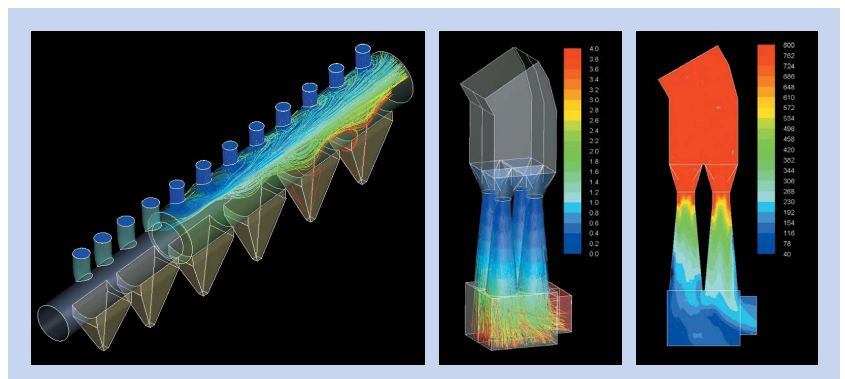

Gas turbine inlet air cooling

Cooling of outdoor air is effective at countering the drop in power output of gas turbines in summer.

IKEUCHI provides gas turbine inlet air cooling systems that guarantee the cooling temperature.

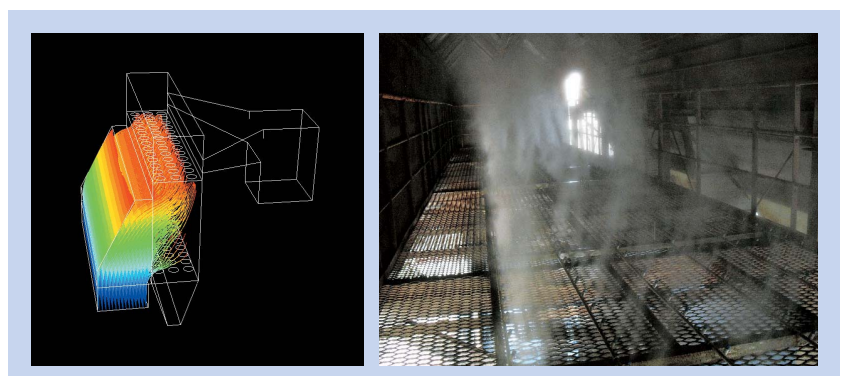

Fog spray cooling systems

We provide custom systems including the appropriate nozzles, equipment and controls to meet our customers' needs.

By utilizing optimal system control technologies it becomes possible to achieve ideal cooling system performance.

Control devices (Valve stand)



Control devices (Control panel)



Profile of supporting data

To aid in cooling nozzle selection, IKEUCHI can perform a variety of measurements and simulations.

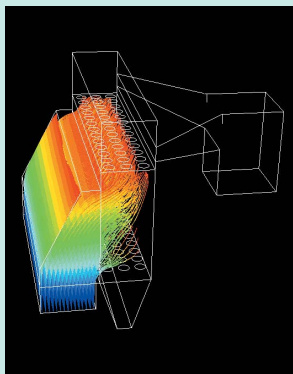

Thermo-fluid analysis data

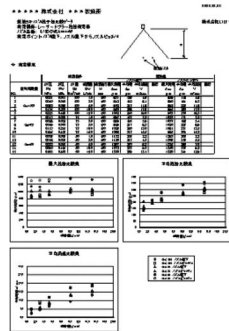

Droplet diameter and speed reference charts

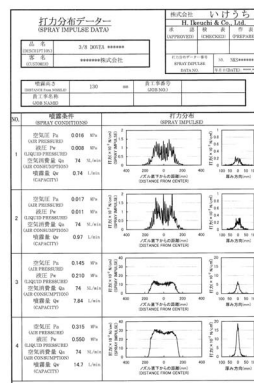

Spray impact distributions across width and thickness (for single unit)

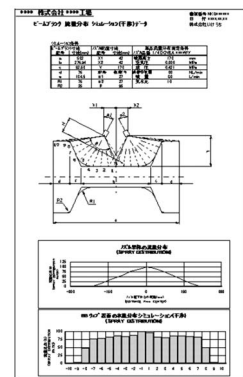

Simulation of flow rate distribution at surface of a beam blank

Nozzle applications for each process

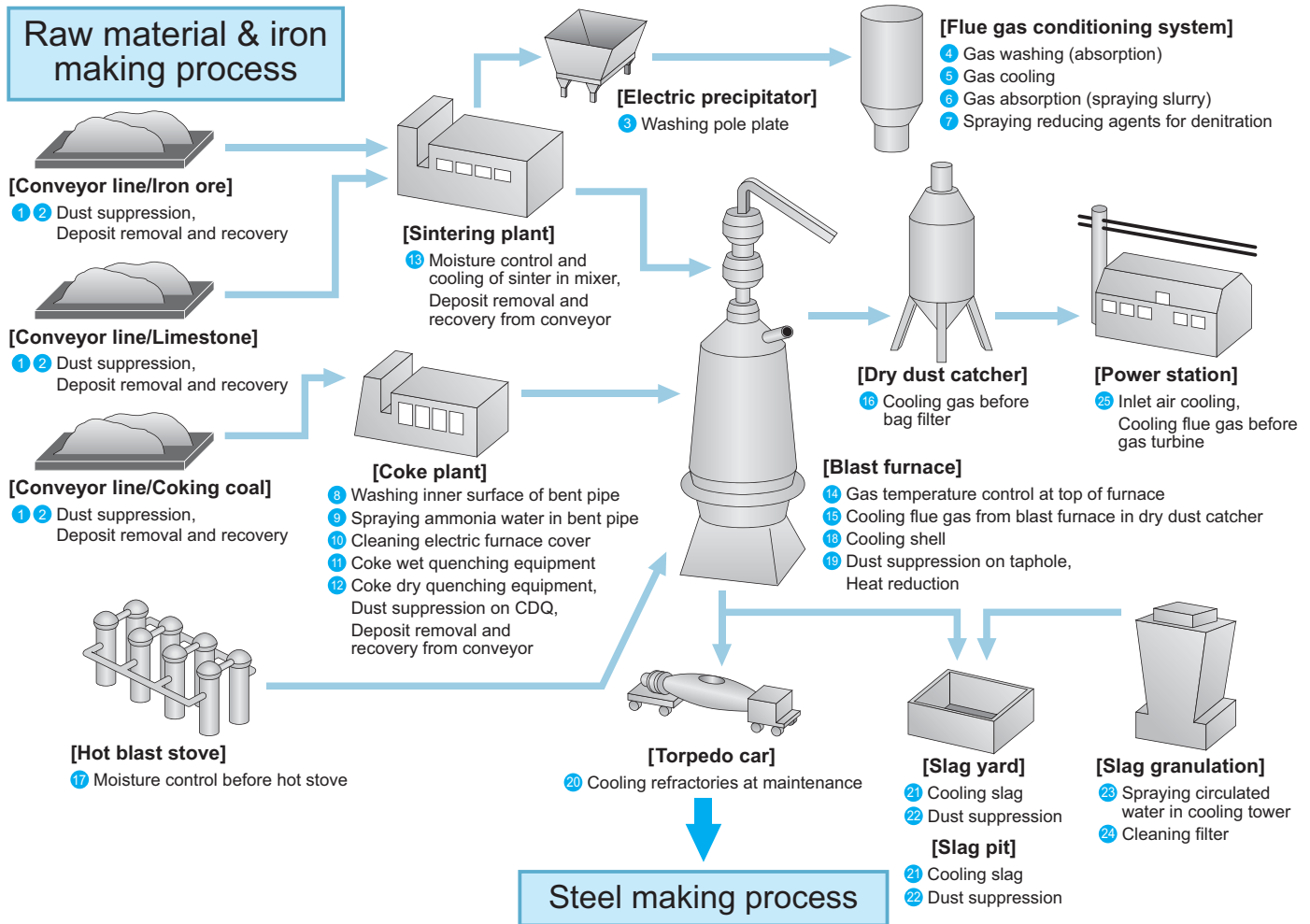

Process	No.	Application	Nozzle series	Nozzle description	Page
Raw material	1	Raw material yard Dust suppression	VVP AJP	• Standard flat spray • Clog-resistant, full cone spray	p.39 p.56
	2	Raw material conveyor line Dust suppression	BIM YYA BAVV CLJ	• Fine fog spray • Wide-angle flat spray • Blower-air driven fine fog spray • Semi-Dry Fog® cooling fan unit	p.24 p.36 p.37 p.76
		Deposit removal and recovery	TAIFUJete	• Air nozzles (long flat type)	p.67
	3	Electric precipitator Washing pole plate	EJVV AJP	• Air mixing type flat spray • Clog-resistant, full cone spray	p.46 p.56
	4	Flue gas conditioning system Gas washing (absorption)	AJP TJXX	• Clog-resistant, full cone spray • Flange type, full cone spray	p.56 p.62
	5	Gas cooling	SPB	• Variable capacity hollow cone spray	p.64
	6	Gas absorption (spraying slurry)	TWAA TAA TJXX	• Wear-resistant, bidirectional hollow cone spray • Wear-resistant, large flow hollow cone spray • Flange type, full cone spray	p.58 p.58 p.62
	7	Spraying reducing agents for denitration	BIM	• Fine fog spray	p.24
	8	Coke plant Washing inner surface of bent pipe	VV+YY	• Dual flat spray	p.49
	9	Spraying ammonia water in bent pipe	AJP	• Clog-resistant, full cone spray	p.56
	10	Cleaning electric furnace cover	CMP-Sa	• Solid steam jet with wear-resistant sapphire tip	p.66
	11	Coke wet quenching equipment	JJXP	• Standard full cone spray	p.54
	12	• Coke dry quenching equipment • Dust suppression on CDQ	GSIMII	• Large capacity fine fog spray	p.29
	Deposit removal and recovery from conveyor	TAIFUJete	• Air nozzles (long flat type)	p.67	
13	Sintering plant Moisture control and cooling of sinter in mixer	AJP CLJ	• Clog-resistant, full cone spray • Semi-Dry Fog® cooling fan unit	p.56 p.76	
	Deposit removal and recovery from conveyor	TAIFUJete	• Air nozzles (long flat type)	p.67	

Process	No.	Application	Nozzle series	Nozzle description	Page
Iron making	14	Blast furnace Gas temperature control at top of furnace	VVP JJXP BBXP	• Standard flat spray • Standard full cone spray • Wide-angle full cone spray	p.39 p.54 p.59
	15	Cooling flue gas from blast furnace in dry dust collector	TJJXP 4SPB	• 7-head full cone spray • Multiple-head SPB series	p.63 p.64
	16	Dry dust catcher Cooling gas before bag filter	SPB	• Variable capacity hollow cone spray	p.64
	17	Hot blast stove Moisture control before hot stove	SPB	• Variable capacity hollow cone spray	p.64
	18	Blast furnace Cooling shell	AJP	• Clog-resistant, full cone spray	p.56
	19	• Dust suppression on taphole • Heat reduction	GSIMII CLJ	• Large capacity fine fog spray • Semi-Dry Fog® cooling fan unit	p.29 p.76
	20	Torpedo car Cooling refractories at maintenance	BIM Header GSIMII	• BIM integrated spray header • Large capacity fine fog spray	p.27 p.29
	21	Slag yard, Slag pit Cooling slag	KKK	• Variable spray angle & flow, hollow cone spray	p.65
	22	Dust suppression	3OV	• 3-head, off-center flat spray	p.65
	23	Slag granulation Spraying circulated water in cooling tower	TAA TJXX	• Wear-resistant, large flow hollow cone spray • Flange type, full cone spray	p.58 p.62
	24	Cleaning filter	VVP VEP	• Standard flat spray • Even flat spray	p.39 *
	25	Power station • Inlet air cooling • Cooling flue gas before gas turbine	GSIMII KB	• Large capacity fine fog spray • Small capacity fine fog hollow cone spray	p.29 *

Remarks: For details of the products marked with *, please contact us.

Nozzle applications for each process

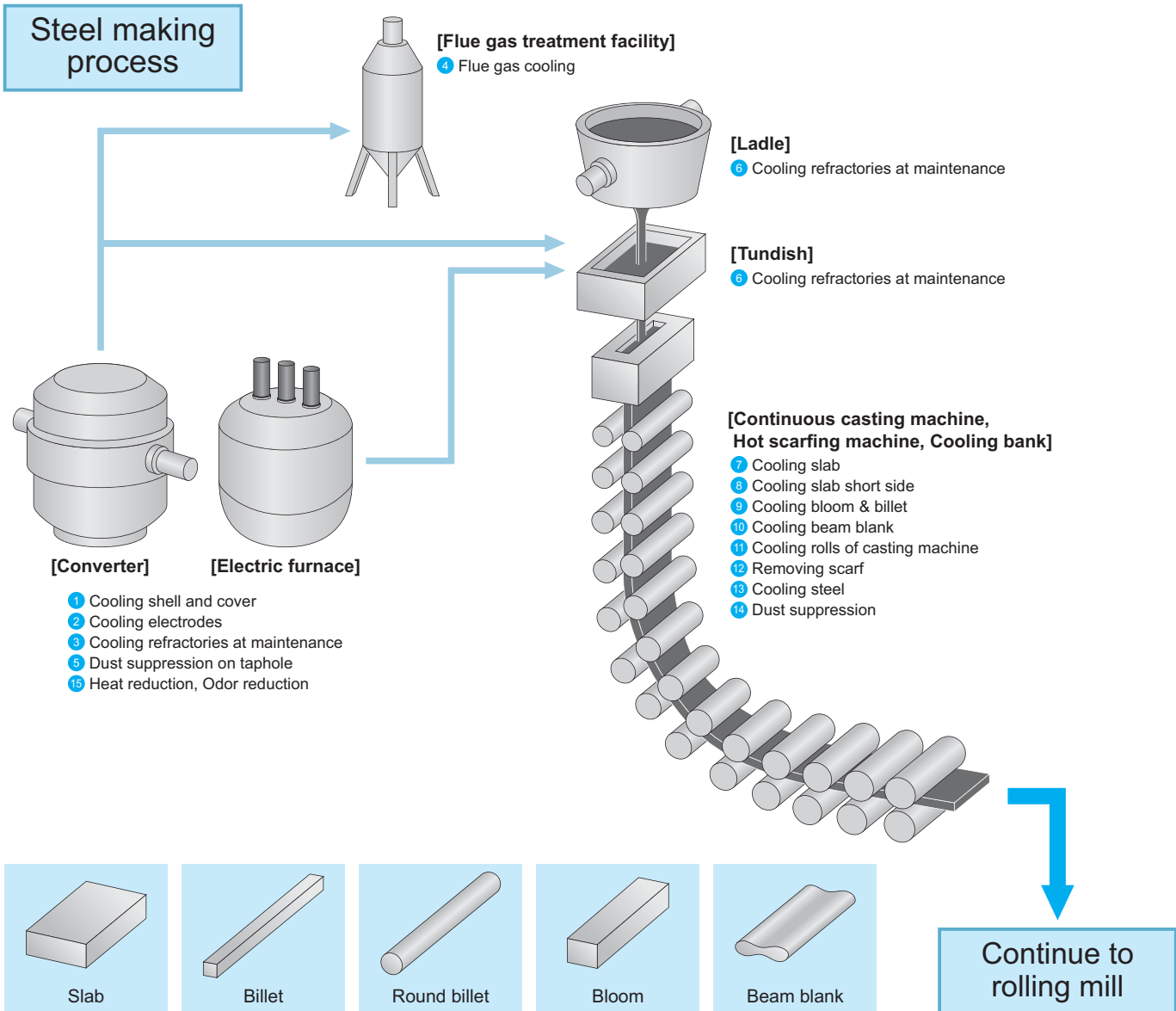

Process	No.	Application	Nozzle series	Nozzle description	Page
Steel making	1	Electric furnace Cooling shell and cover	AJP Wide-angle AJP JJXP	• Clog-resistant, full cone spray • Wide spray angle version of AJP • Standard full cone spray	p.56 p.57 p.54
	2	Cooling electrodes	BIM VVP	• Fine fog spray • Standard flat spray	p.24 p.39
	3	Electric furnace, Converter Cooling refractories at maintenance	GSIMII	• Large capacity fine fog spray	p.29
	4	Flue gas treatment facility Flue gas cooling	GSIMII	• Large capacity fine fog spray	p.29
	5	Electric furnace, Converter Dust suppression on taphole	GSIMII	• Large capacity fine fog spray	p.29
	6	Ladle, Tundish Cooling refractories at maintenance	BIM Header GSIMII CLJ	• BIM integrated spray header • Large capacity fine fog spray • Semi-Dry Fog® cooling fan unit	p.27 p.29 p.76
	7	Continuous casting machine Cooling slab	DOVEA DOVEA-W DDRP+AS VVP+AS	• Even flat spray • Thick even flat spray • Hydraulic/Pneumatic (dual-use) thick even flat spray • Hydraulic/Pneumatic (dual-use) flat spray	p.17 p.18 p.21 p.23
	8	Cooling slab short side	DDA	• Ultra-thick flat spray	p.19

Process	No.	Application	Nozzle series	Nozzle description	Page
Steel making	9	Continuous casting machine Cooling bloom & billet	DDA DDRP+AS VVP+AS VVP WVVP DDRP JJXP BBXP SSXP	• Ultra-thick flat spray • Hydraulic/Pneumatic (dual-use) thick even flat spray • Hydraulic/Pneumatic (dual-use) flat spray • Standard flat spray • Thick flat spray • Ultra-thick even flat spray • Standard full cone spray • Wide-angle full cone spray • Square full cone spray	p.19 p.21 p.23 p.39 p.43 p.47 p.54 p.59 p.61
	10	Cooling beam blank	DOVEA DOVEA-W	• Even flat spray • Thick even flat spray	p.17 p.18
	11	Roll coding	DOVEA DDA DDRP+AS VVP+AS BIM	• Even flat spray • Ultra-thick flat spray • Hydraulic/Pneumatic (dual-use) thick even flat spray • Hydraulic/Pneumatic (dual-use) flat spray • Fine fog spray	p.17 p.19 p.21 p.23 p.24
	12	Hot scarfing machine Removing scarf	VVEP CCP	• Even flat spray • Solid stream jet	p.44 *
	13	Cooling bank Cooling steel	GSIMII CLJ	• Large capacity fine fog spray • Semi-Dry Fog® cooling fan unit	p.29 p.76
	14	Work environment Dust suppression	CLJ KB	• Semi-Dry Fog® cooling fan unit • Small capacity fine fog hollow cone spray	p.76 *
	15	Work environment • Heat reduction • Odor reduction	CLJ LYOHM System	• Semi-Dry Fog® cooling fan unit • Semi-Dry Fog® cooling system	p.76 *

Remarks: For details of the products marked with *, please contact us.

Nozzle applications for each process

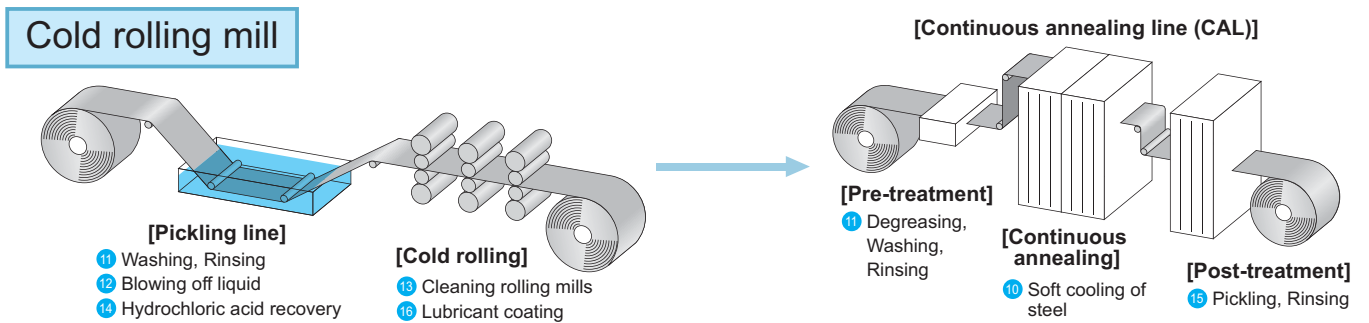
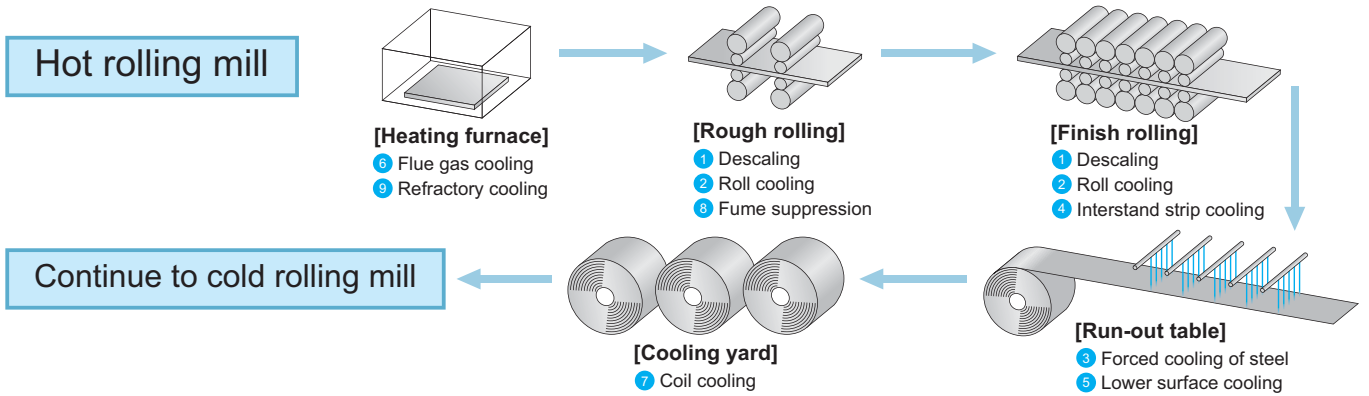
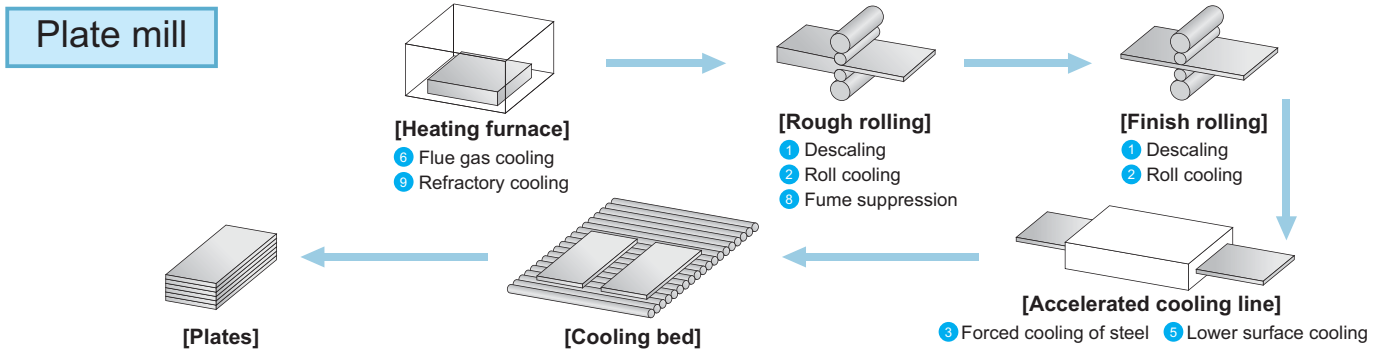

Process	No.	Application	Nozzle series	Nozzle description	Page
Plate mill/Hot rolling mill	1	Rough rolling, Finish rolling Descaling	TDSS	• Descaling	p.12
	2	Roll cooling	VVP WVVP VVEP WVVEP	• Standard flat spray • Thick flat spray • Even flat spray • Thick even flat spray	p.39 p.43 p.44 p.45
	3	Accelerated cooling line/ Run-out table Forced cooling of steel	BAVV WVVP VVEP WVVEP EJVJ OVVEP	• Blower-air driven fine fog spray • Thick flat spray • Even flat spray • Thick even flat spray • Air mixing type flat spray • Off-center even flat spray	p.37 p.43 p.44 p.45 p.46 p.50
	4	Finish rolling Interstand strip cooling	VVP WVVEP DDRP AJP SSXP	• Standard flat spray • Thick even flat spray • Ultra-thick even flat spray • Clog-resistant, full cone spray • Square full cone spray	p.39 p.45 p.47 p.56 p.61
	5	Accelerated cooling line, Run-out table Lower surface cooling	VVP+AS VVP WVVP WVVEP DDRP AJP SSXP	• Hydraulic/Pneumatic (dual-use) flat spray • Standard flat spray • Thick flat spray • Thick even flat spray • Ultra-thick even flat spray • Clog-resistant, full cone spray • Square full cone spray	p.23 p.39 p.43 p.45 p.47 p.56 p.61
	6	Heating furnace Flue gas cooling	GSIMII	• Large capacity fine fog spray	p.29
	7	Cooling yard Coil cooling	VVP LLYOH CLJ	• Standard flat spray • Blower LYOHM header • Semi-Dry Fog® cooling fan unit	p.39 p.71 p.76
	8	Rough rolling Fume suppression	GSIMII	• Large capacity fine fog spray	p.29
	9	Heating furnace Refractory cooling	GSIMII CLJ	• Large capacity fine fog spray • Semi-Dry Fog® cooling fan unit	p.29 p.76

Process	No.	Application	Nozzle series	Nozzle description	Page
Cold rolling mill	10	Continuous annealing Soft cooling of steel	BRASIKan® BIM BAVV MOMoJet® INVV TAIFUJet® LLYOH	• Brush-cleaning nozzle header • Fine fog spray • Blower-air driven fine fog spray • Self-cleaning, flat spray • Quick-detachable standard flat spray • Air nozzles • Blower LYOHM header	p.15 p.24 p.37 p.51 p.52 p.67 p.71
	11	Pickling line CAL/Pre-treatment Degreasing, Washing, Rinsing	BRASIKan® VVP INVV	• Brush-cleaning nozzle header • Standard flat spray • Quick-detachable standard flat spray	p.15 p.39 p.52
	12	Pickling line Blowing off liquid	TAIFUJet® SLNHA-H SLNB	• Air nozzles • Sliit nozzles • Sliit nozzles utilizing blower air	p.67 p.69 p.70
	13	Cold rolling Cleaning rolling mills	MOMO JJXP JA RJ SR ES	• Self-cleaning, flat spray • Standard full cone spray • Rotating tank cleaning nozzle • Low-pressure rotating cleaning • Low-speed rotating cleaning • Rotating cleaning nozzle	p.51 p.54 p.74 p.74 p.75 p.75
	14	Pickling line Hydrochloric acid recovery	INVV JJXP KKB	• Quick-detachable standard flat spray • Standard full cone spray • Fine fog hollow cone spray	p.52 p.54 *
	15	CAL/Post-treatment Pickling, Rinsing	BRASIKan® VVP INVV	• Brush-cleaning nozzle header • Standard flat spray • Quick-detachable standard flat spray	p.15 p.39 p.52
	16	Cold rolling Lubricant coating	BIM Header	• BIM integrated spray header	p.27

Remarks: For details of the products marked with *, please contact us.

Nozzle applications for each process

Surface finish

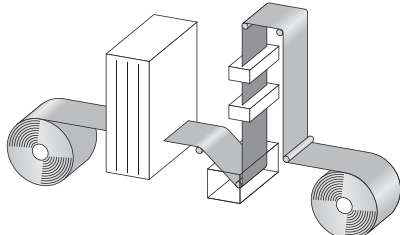

[Continuous galvanizing line (CGL)]

- 1 Minimized spangle treatment
- 2 Cooling top roll and steel sheet after galvanizing
- 3 Blowing off drying, Air cooling, Blowing off dust
- 5 Degreasing, Washing, Rinsing

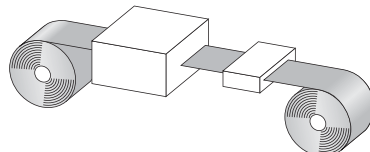
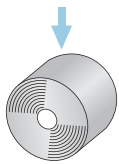

[Electrolytic galvanizing line (EGL)]

- 3 Blowing off liquid
- 4 Fume suppression
- 6 Washing, Chemical rinsing

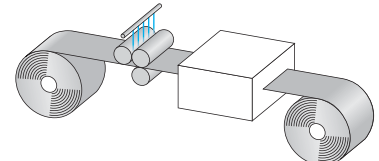
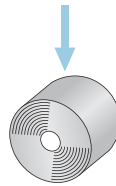

[Continuous coating line (CCL)]

- 3 Blowing off liquid
- 7 Cooling after drying

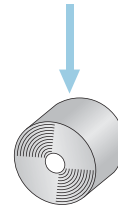

Other processes

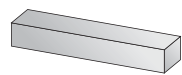

[Billet]



[Bloom]



[Beam blank]

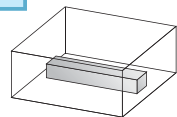

[Reheating furnace]

- 8 Flue gas cooling, Refractory cooling

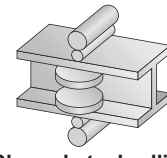

[Shaped steel rolling]

- 9 Descaling, H-shaped steel cooling
- 10 Shaped steel cooling, Blowing off liquid
- 12 Fume suppression

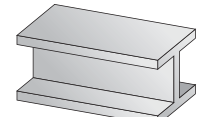

[Shaped steel]

- 14 Steel cooling

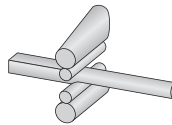

[Wire rod rolling]

- 11 Wire rod cooling, Lubricant coating
- 12 Fume suppression
- 13 Agitation in salt bath



[Wire rod in coil]

- 14 Steel cooling

Process	No.	Application	Nozzle series	Nozzle description	Page
Surface finish	1	CGL Minimized spangle treatment	BIM BIM Header LLYOH	• Fine fog spray • BIM integrated spray header • Blower LYOHM header	p.24 p.27 p.71
	2	Cooling top roll and steel sheet after galvanizing	BIM BIM Header VVEA VVP MOMO INVV	• Fine fog spray • BIM integrated spray header • High impact flat spray • Blower-air driven fine fog spray	p.24 p.27 p.34 p.37
	3	CGL, EGL, CCL Blowing off drying, Air cooling, Blowing off dust Blowing off liquid	VVEA TAIFUJet® SLNHA-H SLNB PSN	• High impact flat spray • Air nozzles • Slit nozzles • Slit nozzles utilizing blower air • Pneumatic slit nozzles	p.34 p.67 p.69 p.70 p.71
	4	EGL Fume suppression	LYOHM System	• Semi-Dry Fog® cooling system	*
	5	CGL Degreasing, Washing, Rinsing	BRASIKane VVEA VVP MOMO INVV ES	• Brush-cleaning nozzle header • High impact flat spray • Standard flat spray • Self-cleaning, flat spray • Quick-detachable standard flat spray • Rotating cleaning nozzles	p.15 p.34 p.39 p.51 p.52 p.75
	6	EGL Washing, Chemical rinsing	VVEA VVEP MOMO INVV PSN	• High impact flat spray • Even flat spray • Self-cleaning, flat spray • Quick-detachable standard flat spray • Pneumatic slit nozzles	p.34 p.43 p.51 p.52 p.71
	7	CCL Cooling after drying	BIM Header LLYOH	• BIM integrated spray header • Blower LYOHM header	p.27 p.71

Remarks: For details of the products marked with *, please contact us.

Process	No.	Application	Nozzle series	Nozzle description	Page
Other processes	8	Reheating furnace Flue gas cooling	GSIMII	• Large capacity fine fog spray	p.29
		Refractory cooling	GSIMII CLJ	• Large capacity fine fog spray • Semi-Dry Fog® cooling fan unit	p.29 p.76
	9	Shaped steel rolling Descaling	TDSS	• Descaling	p.12
		H-shaped steel cooling	EJVV DDRP WOVVEP	• Air mixing type flat spray • Ultra-thick even flat spray • Off-center thick even flat spray	p.46 p.47 p.50
	10	Shaped steel rolling • Shaped steel cooling • Blowing off liquid	VVP OVVEA TAIFUJet®	• Standard flat spray • Off-center even flat spray • Air nozzles	p.39 * p.67
	11	Wire rod rolling • Wire rod cooling • Lubricant coating	BIM	• Fine fog spray	p.24
Work environment	12	Shaped steel rolling, Wire rod rolling Fume suppression	GSIMII	• Large capacity fine fog spray	p.29
	13	Wire rod rolling Agitation in salt bath	EJX	• Ejector nozzles for solution agitation	*
	14	Shaped steel, Wire rod in coil Steel cooling	GSIMII CLJ	• Large capacity fine fog spray • Semi-Dry Fog® cooling fan unit	p.29 p.76
		Work environment Dust suppression	CLJ KB	• Semi-Dry Fog® cooling fan unit • Small capacity fine fog hollow cone spray	p.76 *
		Heat reduction	CLJ LYOHM System	• Semi-Dry Fog® cooling fan unit • Semi-Dry Fog® cooling system	p.76 *
		Spraying water on road	YYP	• Wide-angle flat spray	*
	Fire prevention • Fire fighting/Fire prevention • Water curtain	VVP AJP BBXP YYP CCP	• Standard flat spray • Clog-resistant, full cone spray • Wide-angle full cone spray • Wide-angle flat spray • Solid stream jet	p.39 p.56 p.59 * *	

Remarks: For details of the products marked with *, please contact us.

Spray Nozzle Materials

In this catalog the materials of nozzles are described using the material codes listed below.

As "The Fog Engineers", we, IKEUCHI, have been developing nozzles in a variety of materials to meet the desires and applications of our customers. We were the first to develop ceramic orifice-inserted spray nozzles and succeed in marketing them throughout the world.

Listed below are the materials of nozzles and parts, and resistance characteristics of each material against common chemicals.

Metals	[Material code.....Material]
	S303.....Stainless steel 303
	S304.....Stainless steel 304
	S316.....Stainless steel 316
	S316L.....Stainless steel 316L
	SCS13.....Die-cast stainless steel equiv. to S304
	SCS14.....Die-cast stainless steel equiv. to S316
	SCS16.....Die-cast stainless steel equiv. to S316L
	S420J2.....Hardened stainless steel 420J2
	B.....Brass (C3604)
	TN.....Titanium
Tungsten carbide	

Rubbers	[Material code.....Material]
	NBR.....Nitrile rubber
	FKM.....Fluororubber
	FEPM.....Tetrafluoroethylene-propylene rubber
	EPDM.....Ethylene-propylene rubber

Ceramics	CERJET® ceramics
	Alumina ceramics (Alumina 92%, etc.)
	[Material code.....Material]
	SiC.....Silicon nitride bonded silicon carbide
SiSiC.....Sintered reaction-bonded silicon carbide	

Plastics	[Material code.....Material]
	PP.....Polypropylene
	PPS.....Polyphenylene sulfide
	PVC.....Polyvinyl chloride
	HTPVC.....Heat-treated polyvinyl chloride
	PTFE.....Polytetrafluoroethylene
	PVDF.....Polyvinylidene fluoride
	ABS.....Acrylonitrile butadiene styrene
	FRPP.....Glass-fiber reinforced polypropylene
	FRP.....Fiber-reinforced plastic
	PE.....Polyethylene
Ultrahigh molecular weight polyethylene (UHMWPE)	
Araldite®H.....High-temperature epoxy resin (Adhesive)	

Araldite is the registered trademark of Huntsman Advanced Materials.

Others	[Material code.....Material]
	Sa.....Sapphire

Items	Materials	Chemical resistance											Heat resistance		
		Hydrochloric acid	Concentrated Hydrochloric acid	Sulfuric acid (35%)	Concentrated sulfuric acid	Nitric acid (35%)	Concentrated nitric acid	Acetic acid	Sodium hydroxide (caustic soda)	Aqueous ammonia	Acetone	Trichloroethylene	Ethyl alcohol	Suitable (°C)	Short-term use only (°C)
Metals	S303	x	x	x	x	○	△	△	○	○	○	○	○	400	800
	S304	x	x	x	x	○	○	○	○	○	○	○	○	400	800
	S316, S316L	x	x	x	○	○	△	○	○	○	○	○	○	400	800
	B	x	x	x	x	x	x	x	△	△	○	○	○	200	400
	TN	△	x	x	x	○	○	○	○	○	○	○	○	500	1,000
Plastics	PP	○	△	○	x	x	x	○	○	○	○	△	○	80	90
	PPS	○	○	○	△	△	x	○	○	○	○	○	○	170	180
	PVC	○	○	○	○	○	x	○	○	○	x	x	○	40	50
	PTFE	○	○	○	○	○	○	○	○	○	○	○	○	100	150
	PVDF	○	○	○	○	○	○	○	△	○	x	○	○	80	120
	ABS	△	△	△	x	x	x	x	△	○	x	x	△	80	90
	FRPP	○	△	○	x	x	x	○	△	○	○	△	○	90	100
	UHMWPE	○	○	○	x	△	x	○	○	○	△	△	○	80	100
	Araldite®H	○	x	○	△	x	x	○	△	○	○	○	○	120	140
Rubbers	NBR	x	x	x	x	x	x	○	○	○	x	△	○	90	120
	FKM	○	○	○	○	○	○	○	△	x	x	○	○	150	200
	FEPM	○	○	○	○	○	○	○	○	x	x	○	○	150	200
	EPDM	○	△	○	△	x	x	○	○	○	○	x	○	90	120
Ceramics	CERJET® ceramics	○	○	○	○	○	○	○	x	○	○	○	○	700	800
	Alumina ceramics	○	○	○	○	○	○	○	△	○	○	○	○	1,000	1,200
	SiC	○	○	○	○	○	○	○	△	○	○	○	○	1,550	1,550
	SiSiC	○	○	○	○	○	○	○	△	○	○	○	○	1,350	1,350
Others	Sa	○	○	○	○	○	○	○	○	○	○	○	○	-	-

Note:

- The heat resistance (operating temperature limit) of spray nozzles varies widely depending on the operating conditions, environment, liquid sprayed, etc.
- Ceramic should be used at temperatures under 100°C to avoid a crack caused by heat shock.
- As for the spray nozzles including adhesive, please also take into account the heat/chemical resistance of the adhesive.

-Suitable
- △.....Possible for short term
- x.....Unusable

How to Read the Tables

Shows steel making process where this nozzle is used, and its application (See the pages 6–9 for nozzle applications for each process)

Descaling nozzles

TDSS series Descaling Nozzles

Patented

Rolling Mills Descaling

FEATURES

- Stabilizing strainer for making perfect straight flow.
- Unique nozzle tip design produces razor-like sharp stream.
- Water saving descaling nozzle, achieving higher impact with less water.

Photo of nozzle spraying under standard pressure

Material description: In our catalogs and drawings, "S" represents "stainless steel", "B" represents "Brass C3604". For the other material codes, please refer to "Spray Nozzle Materials" on page 10.

Technical data and examples of use are shown.

TDSS series

Offset angle: Left (L) Right (R)

MATERIALS

A Nozzle tip

- Standard nozzle tip/Tip with cover
 - Tip: Tungsten carbide
 - Tip body: S303
- Long nose nozzle tip
 - Tip: Tungsten carbide
 - Tip body: S304

③ Packing: Copper

B Stabilizing strainer

- Standard/Long strainer
 - Strainer adaptor: Brass
 - Strainer: Brass or S316L*
 - Stabilizer: S316L
- Strainer with check valve
 - Strainer adaptor: Brass
 - Check valve adaptor: S403
 - Piston valve: S303
 - Spring: S304
 - Strainer: Brass or S316L*
 - Stabilizer: S316L

① Nozzle tip (① Tip ② Tip body)

③ Packing

④ Stabilizing strainer (④ Strainer adaptor ⑤ Stabilizer ⑥ Strainer)

Types of Strainers	Outer dimensions (mm)			
	L1	L2	øD	a
Standard strainer (type B)	126	52	30	25
Long strainer (type E)	173	52	30	25
Strainer with check valve (type LCV)	180	52	30	25.5

Performance table

Thread type and size of spray nozzle (R1/4")

Spray angle at the specified pressure (124° at 0.7 MPa)

At 0.05 MPa, defined spray pattern does not develop

Calculated spray capacity at the specified pressure (0.21 ℓ/min at 0.15 MPa)

Spray capacity code (03)

Spray angle code (115)

Spray angle code	Spray capacity code	Pipe connection size		Spray angle (°)			Spray capacity (ℓ/min)								
		All metal		All plastic		0.15 MPa	0.3 MPa	0.7 MPa	0.05 MPa	0.1 MPa	0.15 MPa	0.2 MPa	0.3 MPa	0.5 MPa	0.7 MPa
		R1/8	R1/4	R3/8	R1/2	R3/4	R1	R1/8	R1/4	MPa	MPa	MPa	MPa	MPa	MPa
03	03	○	○	○	○	○	○	○	○	○	○	○	○	○	○
04	04	○	○	○	○	○	○	○	○	○	○	○	○	○	○
05	05	○	○	○	○	○	○	○	○	○	○	○	○	○	○
07	07	○	○	○	○	○	○	○	○	○	○	○	○	○	○
10	10	○	○	○	○	○	○	○	○	○	○	○	○	○	○
15	15	●	●	○	○	○	○	○	○	○	○	○	○	○	○
20	20	●	●	○	○	○	○	○	○	○	○	○	○	○	○
30	30	●	●	○	○	○	○	○	○	○	○	○	○	○	○
40	40	●	●	○	○	○	○	○	○	○	○	○	○	○	○
60	60	○	○	○	○	○	○	○	○	○	○	○	○	○	○
80	80	○	○	○	○	○	○	○	○	○	○	○	○	○	○

●○ Shows availability of the item
 ●: With strainer
 ○: Without strainer
 No mark: Not available

How to order

Please inquire or order for a specific nozzle using this coding system.

<Example> 1/8M SSXP 020 S303

1/8M	SSXP	020	S303
Pipe conn. size		Spray capacity code	Material
1/8M		020	S303
1M		80	B

Threads noted in this catalog are tapered pipe threads unless otherwise advised.

In "How to order" section, "M" of the pipe connection size indicates male thread ("R" of the ISO standard) and "F" indicates female thread ("Rc" of the ISO standard).

(Example)
 1/4M: 1/4" male taper pipe thread, R1/4
 1/4F: 1/4" female taper pipe thread, Rc1/4

TDSS series Descaling Nozzles

Rolling Mills

Descaling

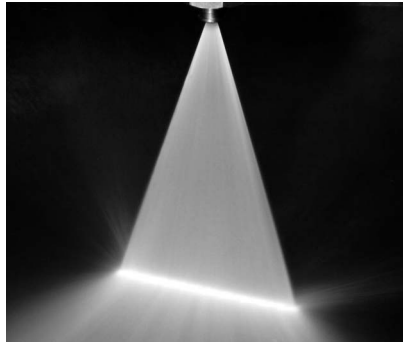
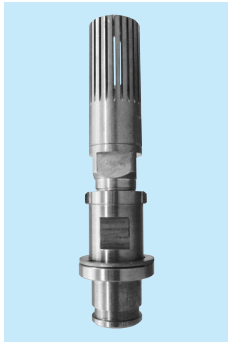

FEATURES

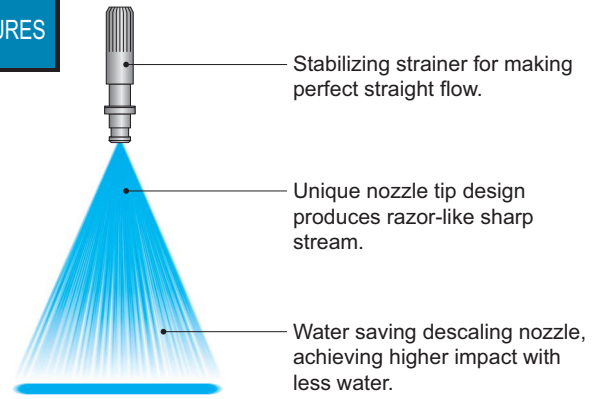

TDSS series

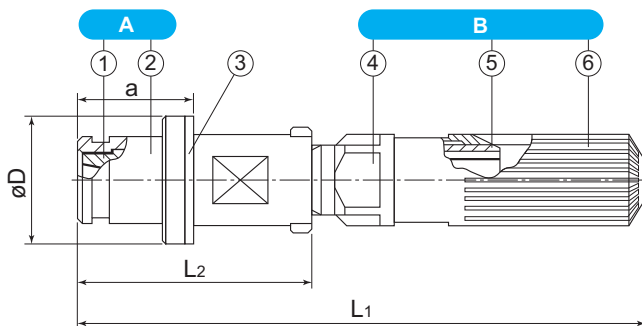
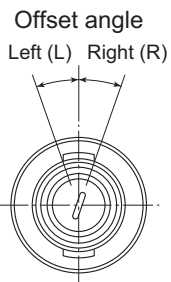

MATERIALS

A Nozzle tip

- Standard nozzle tip/Tip with cover
 - Tip: Tungsten carbide
 - Tip body: S303
- Long nose nozzle tip
 - Tip: Tungsten carbide
 - Tip body: S304

③ Packing: Copper

B Stabilizing strainer

- Standard/Long strainer
 - Strainer adaptor: Brass
 - Strainer: Brass or S316L*
 - Stabilizer: S316L
- Strainer with check valve
 - Strainer adaptor: Brass
 - Check valve adaptor: S403
 - Piston valve: S303
 - Spring: S304
 - Strainer: Brass or S316L*
 - Stabilizer: S316L

A Nozzle tip (①Tip ②Tip body)

③ Packing

B Stabilizing strainer (④Strainer adaptor ⑤Stabilizer ⑥Strainer)

Types of Strainers	Outer dimensions (mm)			
	L1	L2	øD	a
Standard strainer (type B)	126	52	30	25
Long strainer (type E)	173	52	30	25
Strainer with check valve (type LCV)	180	52	30	25.5

TDSS nozzle parts lineup

Standard type

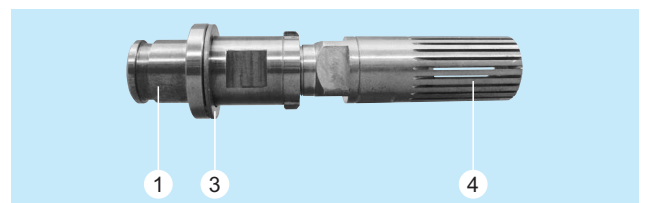
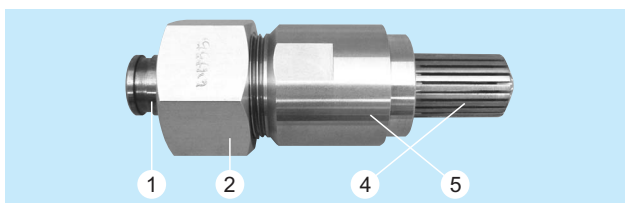

1 Nozzle tip

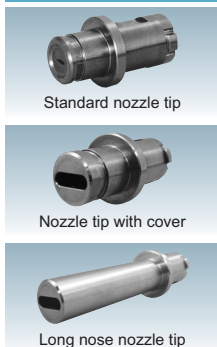

2 Cap

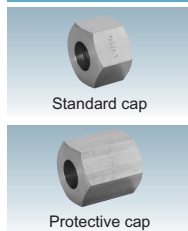

3 Packing



4 Stabilizing strainer

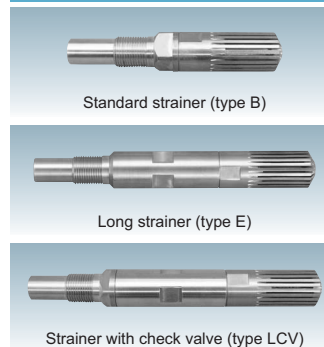

5 Adaptor

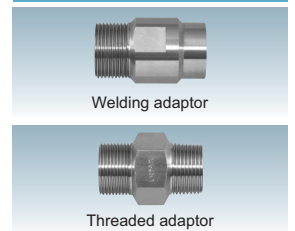

*Strainer material: Brass (except for strainer with free passage diameter ø1)

Uniquely designed descaling nozzle

TDSS series is designed to have no sharp protrusions inside its orifice, which minimizes energy-losses and maximizes the speed and spray impact of water flow, as well as the tip lifespan, even under high-pressure spraying.

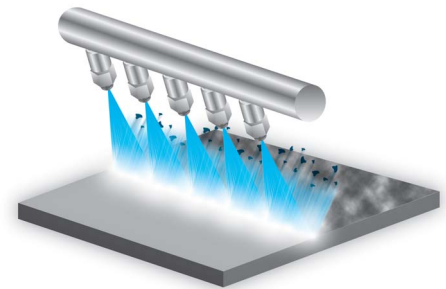

Conventional descaling nozzles

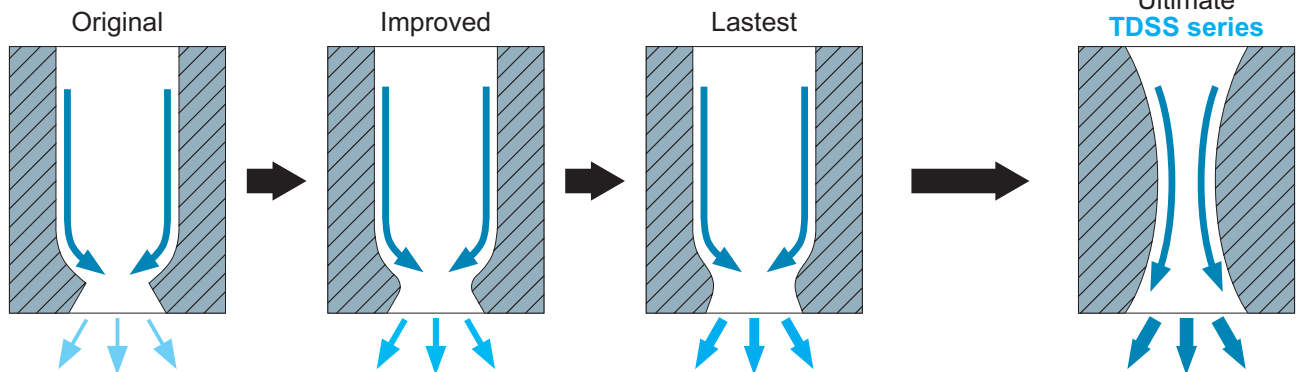

Three features of its unique design

Razor-like Thin Stream

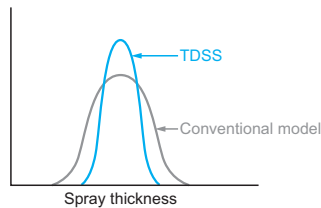

TDSS's **razor-like thin stream** has 20% higher impact compared to the conventional nozzles. TDSS is designed to have uniform spray impact on the cross direction.

Thin Stream High Impact

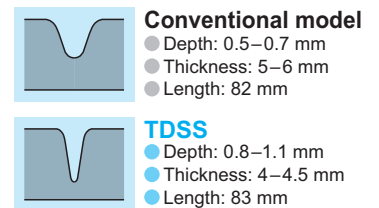

TDSS, with **much higher spray impact**, increases erosion depth by 20% compared to conventional model. Minimizing remaining scales improves productivity and quality.

High Impact Water Saving

Even with **10–20% less water**, TDSS provides the same spray impact as the conventional model.

	Conventional model	TDSS
Erosion depth	1.3 mm	1.3 mm
Spray capacity	134 l/min	110 l/min

Water saving effect

Example: Operating 2 hours a day, a TDSS series nozzle achieves

↓

Water savings of 3 tons per day and **1,100 tons** per year.

Offset angle changes descaling effect

● Offset angle

Water sprayed from nozzles often overlaps and weakens the spray impact force at the edges of the spray width. You can prevent the resultant scale remnants by providing a suitable offset angle (5–10 degrees).

● Offset angle 15°

Photo of spray

Photo of erosion test

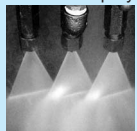

● Erosion depth: 0.6 to 0.9 mm (Nozzle: TDSS40083)

● Offset angle 5°

Photo of spray

Photo of erosion test

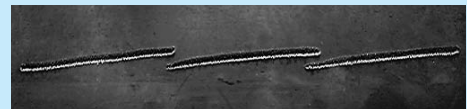
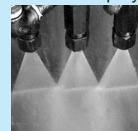

● Erosion depth: 1.0 to 1.3 mm (Nozzle: TDSS32083)

BRASIKan®
series

Manual Brush-cleaning Nozzle Header

Surface finish

- Rinsing and pickling on the surface of steel plates
- Brush roll cleaning
- Cooling steel plate

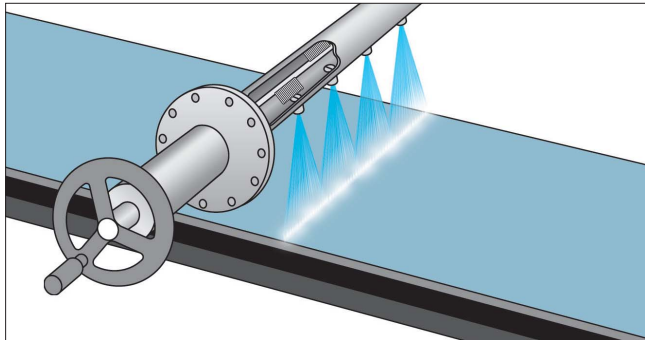

FEATURES

Design allows brushes to easily remove foreign objects.

By rotating an internal brush, nozzle orifices are cleaned thoroughly.

Foreign objects are flushed away while the internal brushes are rotated.

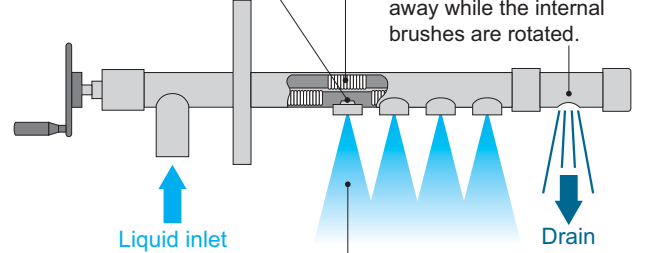

Liquid inlet

Drain

Brushes are turned by hand.

Mountain-shaped distribution to obtain a uniform spray distribution in multiple-nozzle arrangements.

Easily and effectively flush out foreign objects

By turning the handwheel an internal rotating brush scrubs the nozzle orifices to and discharges the debris. Ideal for applications where nozzle clogging is a concern and maintenance is difficult.

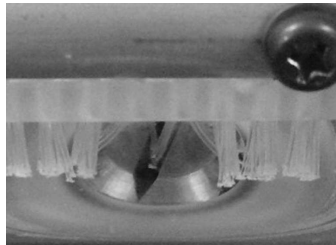

Inner brushes clean the nozzle orifice thoroughly.

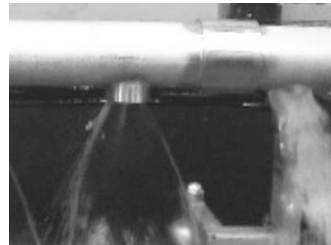

Foreign objects inside the pipe are flushed out through the drain.

Even spray distribution

BRASIKan® spray nozzles are designed to produce a mountain-shaped distribution in order to obtain a uniform spray distribution in multiple nozzle arrangements. Thus BRASIKan® is ideal for applications requiring even spray distribution.

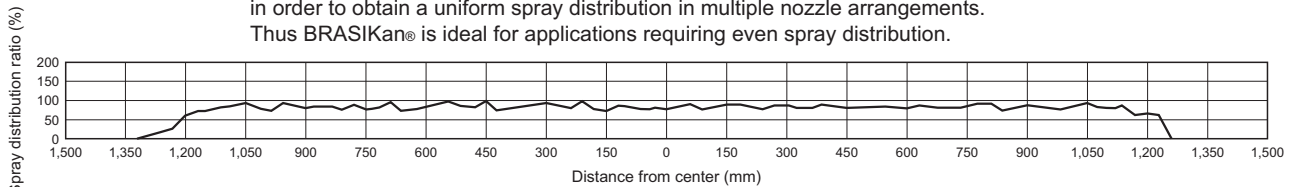

■ Measuring conditions: 10 spray nozzles having 65° spray angle and 12 l/min spray capacity (per 1 pc.) at 0.3 MPa measured at spray pressure of 0.3 MPa and spray height of 275 mm, with nozzle spacing 250 mm.

BRASIKan® series

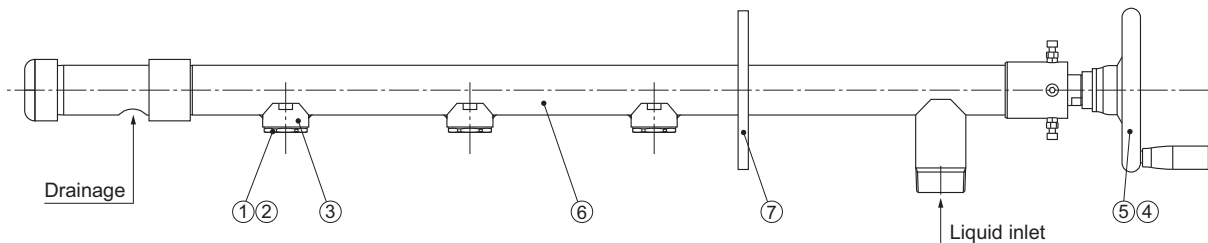

- ① Nozzle
- ② Hexagon cap
- ③ Nozzle adaptor
- ④ Brush (installed inside of the pipe coupled with the handwheel)

- ⑤ Handwheel
- ⑥ Header pipe
- ⑦ Fixing flange

Liquid inlet

Materials (depend on the liquid sprayed)

Liquid	Nozzle	Header (pipe)	Brush	Gasket
Water	S303	S304	PP / S304	PTFE
Alkaline / special liquids	S316L	S316 / S316L	S316L	PTFE
Acidic liquid	TN	FRP	PP	PTFE

Pipe

Pipe size
40A, 50A

Special product

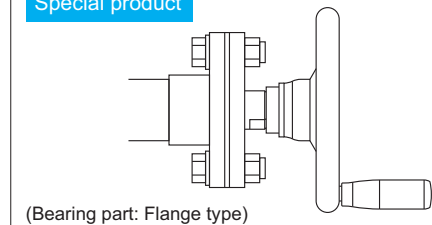

(Bearing part: Flange type)

Nozzle specifications (per one nozzle)

Spray angle code	Spray capacity code	Spray capacity (ℓ/min)				Free passage diameter (mm)
		0.2 MPa	0.3 MPa	0.5 MPa	0.7 MPa	
65	40	3.27	4.00	5.16	6.11	1.3
	60	4.90	6.00	7.75	9.17	1.6
	80	6.53	8.00	10.3	12.2	1.8
	100	8.17	10.0	12.9	15.3	2.1
	120	9.80	12.0	15.5	18.3	2.2
	160	13.1	16.0	20.7	24.4	2.6
	200	16.3	20.0	25.8	30.6	2.9

BRASIKan® series

Air-driven Automatic Brush-cleaning Nozzle Header

Operation mode

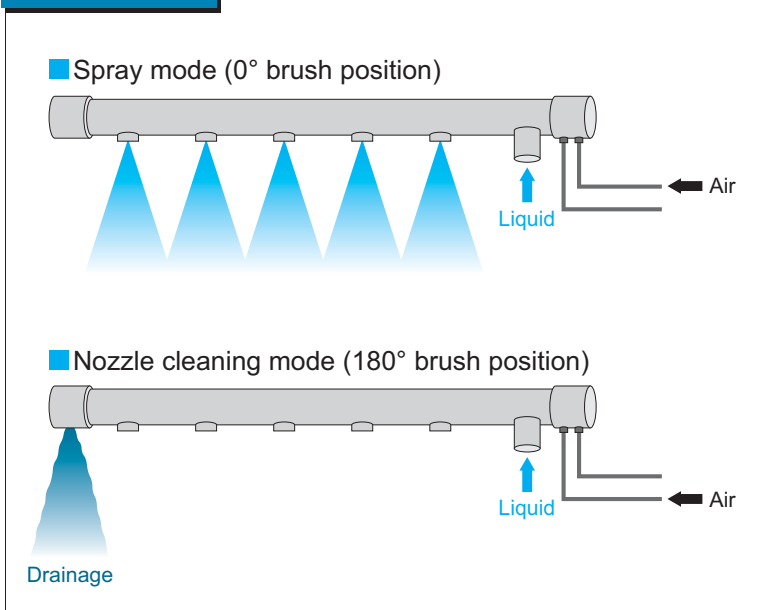

FEATURES

- The air-driven type BRASIKan allows remote control of spray and cleaning modes.
- Setting nozzle for automatic cleaning is also possible with a timer. Brush position rotates from 0° to 180°, and cleans the nozzle orifices thoroughly.
- Having no manual handle, it can be installed in a narrow, inaccessible place.

Control methods

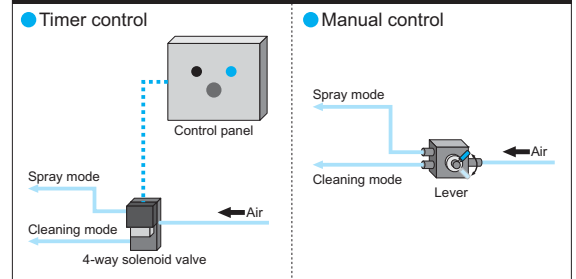

BRASIKan® series

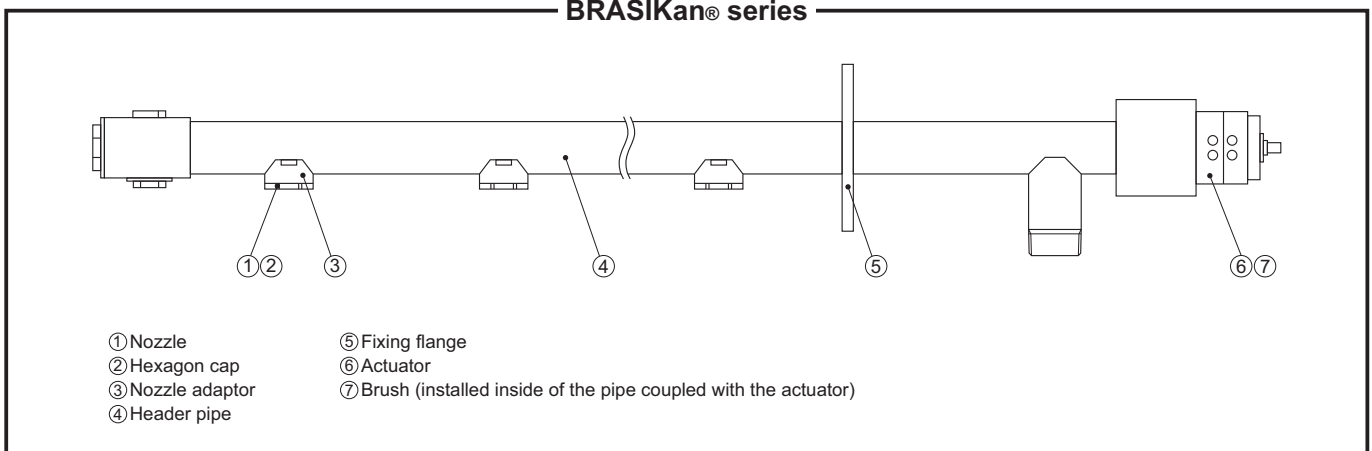

How to order

Inquiry drawing forms are available to ensure we can correctly meet the specifications you require. Please inquire with us for details.

DOVEA series

Secondary Cooling

Flat Spray Nozzles with Even Distribution

Steel making process

- Cooling slab, bloom, beam blank
- Roll cooling



FEATURES

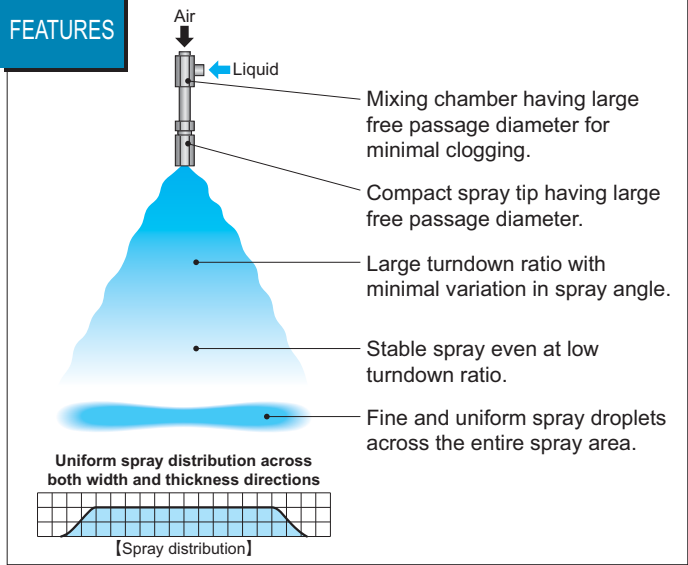

DOVEA series

MATERIALS

- ① Nozzle: S303
- ② Pipe: S304
- ③ Mixing adaptor: S304
- ④ Liquid pipe: S304

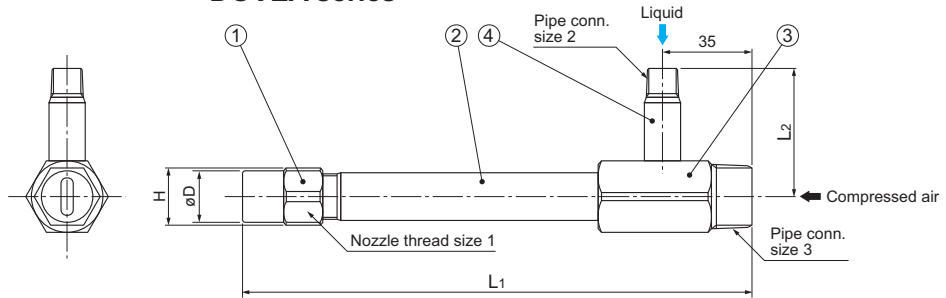

Spray capacity code	Nozzle thread size			Pipe connection sizes				Outer dimensions (mm)				Mass ² (g)
	1	2	3	L1 ¹	L2	H	øD					
82	Rc1/4	R1/4	R1/2	500	47.5	19	18	550				
110												
180	Rc3/8	R1/4	R1/2	500	47.5	21	19	650				
230												
400	Rc1/2	R1/4	R1/2	500	47.5	26	25	850				

*1) L1 = 200–1500 mm

*2) The mass shown is when L1 is 500 mm of straight pipe. For the mass of DOVEA with a longer/shorter pipe, add or subtract the corresponding mass (listed below) for each 100 mm of L1 length, according to the Nozzle thread size 1.

Nozzle thread size 1	Mass per 100 mm
Rc1/4	63 g
Rc3/8	85 g
Rc1/2	130 g

Pneumatic spray nozzle flow rate control for CCM

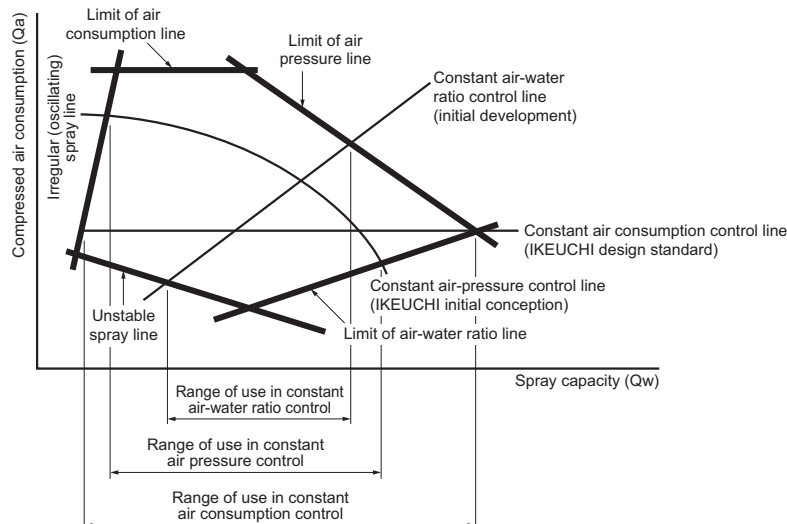

Wide flow control range can meet various casting conditions.

DOVEA series
Secondary Cooling/ Flat Spray Nozzles with Even Distribution

Spray angle code ³	Spray capacity code	Air pressure (MPa)	Spray capacity (ℓ/min) & Air consumption (ℓ/min, Normal)					Mean droplet dia. (μm)		Free passage dia. (mm)		
			Liquid pressure (MPa)					Immersion sampling method	Fraunhofer diffraction method	Spray tip	Adaptor	
			0.07 Liquid / Air	0.1 Liquid / Air	0.2 Liquid / Air	0.4 Liquid / Air	0.7 Liquid / Air				Liquid	Air
110	180	0.1 0.2 0.3 0.4	0.92 / 275 — — —	3.18 / 180 — — —	9.21 / 65 4.34 / 280 — —	— 12.9 / 100 9.49 / 250 —	— — 18.0 / 100 15.9 / 200	100– 350	50– 175	2.7	3.6	5.1
	400	0.1 0.2 0.3 0.4	2.05 / 620 — — —	7.07 / 410 — — —	20.5 / 150 9.65 / 630 — —	— 28.6 / 220 21.1 / 560 —	— 40 / 225 35.4 / 450	100– 400	50– 200	4.1	5.2	7.7
95	82	0.1 0.2 0.3 0.4	0.42 / 125 — — —	1.45 / 85 — — —	4.19 / 30 1.98 / 125 — —	— 5.86 / 45 4.32 / 110 —	— 8.2 / 45 7.26 / 90	100– 300	50– 150	2.0	2.5	3.5
	180	0.1 0.2 0.3 0.4	0.92 / 275 — — —	3.18 / 180 — — —	9.21 / 65 4.34 / 280 — —	— 12.9 / 100 9.49 / 250 —	— 18.0 / 100 15.9 / 200	100– 350	50– 175	3.0	3.6	5.1
	400	0.1 0.2 0.3 0.4	2.05 / 620 — — —	7.07 / 410 — — —	20.5 / 150 9.65 / 630 — —	— 28.6 / 220 21.1 / 560 —	— 40 / 225 35.4 / 450	100– 400	50– 200	4.5	5.2	7.7
70	110	0.1 0.2 0.3 0.4	0.56 / 180 — — —	1.94 / 120 — — —	5.63 / 40 2.65 / 180 — —	— 7.87 / 65 5.8 / 160 —	— 11.0 / 65 9.74 / 130	100– 300	50– 150	2.8	2.8	4.1
	230	0.1 0.2 0.3 0.4	1.18 / 355 — — —	4.07 / 240 — — —	11.8 / 85 5.55 / 370 — —	— 16.4 / 130 12.1 / 320 —	— 23.0 / 130 20.4 / 260	100– 350	50– 175	4.1	4.0	5.9
55	400	0.1 0.2 0.3 0.4	2.05 / 620 — — —	7.07 / 410 — — —	20.5 / 150 9.65 / 630 — —	— 28.6 / 220 21.1 / 560 —	— 40 / 225 35.4 / 450	100– 400	50– 200	5.6	5.2	7.7

*3) Spray angle measured at compressed air pressure of 0.3 MPa and liquid pressure of 0.7 MPa.

Conversion of unit [Pressure] 0.1 MPa ≈ 14.50 psi [Flow rate] 1 ℓ (liter) ≈ 0.26 US gal.
10 psi ≈ 0.07 MPa 1 US gal. ≈ 3.79 ℓ (liter)

How to order

Please inquire or order for a specific nozzle using this coding system.

<Example> 1/4 DOVEA 95 82 -M× 500 S303 - n

1/4	DOVEA	95	82	-M×	500	S303 -	n
Nozzle thread size 1		Spray angle code	Spray capacity code		Total length L ₁		Code of bent pipe
■ 1/4 ■ 3/8 ■ 1/2		■ 110 ■ 95 ■ 70 ■ 55	■ 82 ■ 400		■ Min. 200 ■ Standard 500 ■ Max. 1500		This code will be determined upon receipt of an inquiry.

Sister product

DOVEA-W series

Secondary Cooling

Flat Spray Nozzles -Wider Spray Thickness-

Double-wide* spray thickness makes a difference in cooling applications

*Comparison with DOVEA

The increased thickness of the flat spray from this nozzle allows for more effective cooling in the space between rolls.

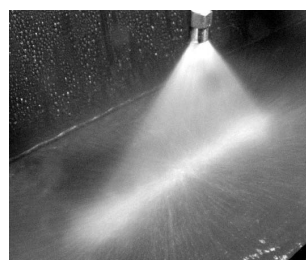

DOVEA-W series



Conventional nozzles (DOVEA series)

DDA series

Secondary Cooling

Ultra-Thick Flat Spray Nozzles

Steel making process

- Cooling bloom, slab short side, billet
- Roll cooling

Heat treatment process

- Cooling magnetic steel

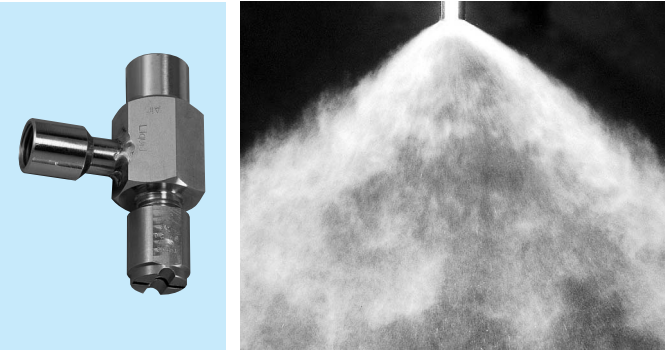

FEATURES

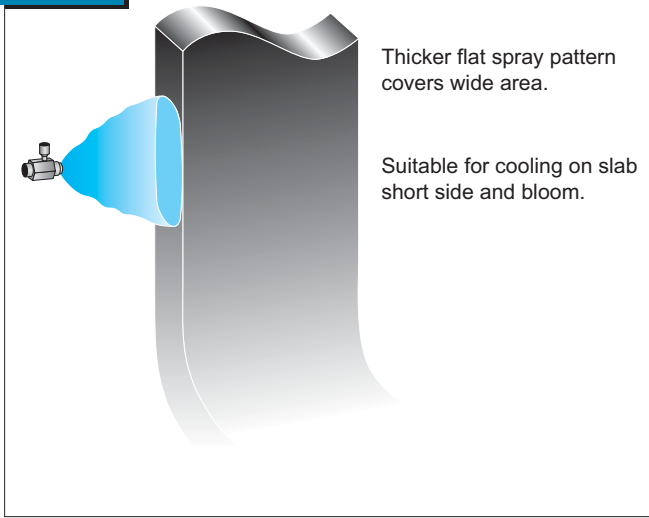

DDA series

MATERIALS

- ① Nozzle body: S303
- ② Pipe: S304
- ③ Mixing adaptor: S304
- ④ Liquid socket: S304

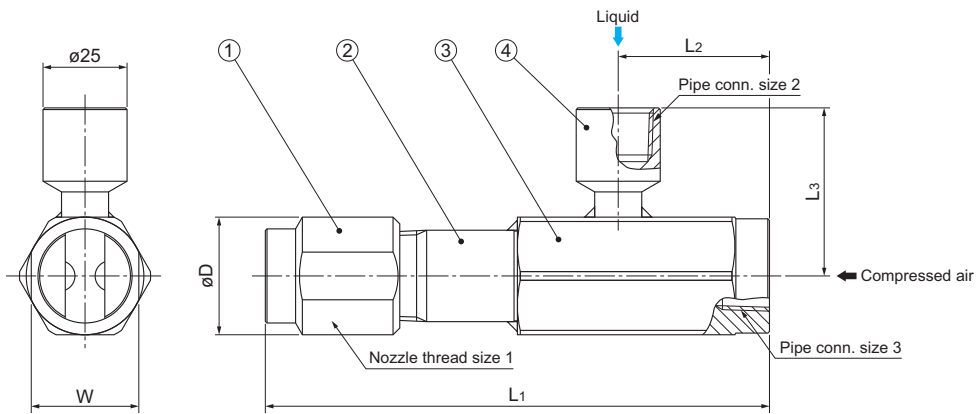

Nozzle thread size 1	Pipe connection sizes 2 & 3 ²	Outer dimensions (mm)					Mass ³ (g)
		L ₁ ¹	L ₂	L ₃	W	øD	
Rc1/8	Rc1/4	70	32.5	40	16	18	170
Rc1/4	Rc1/4	70	32.5	40	16	18	180
Rc1/2	Rc1/2	130	40	50	25	28	450
Rc3/4	Rc1/2	150	45	50	32	35	650

*1) L₁ shows the standard length, which is the shortest, and the longest length is 1500 mm.
 *2) Pipe connection sizes for air and liquid are the same.
 *3) Each mass shows DDA with standard length (L₁).
 For longer lengths, add the corresponding mass (listed below) for each 100 mm of length.

Nozzle thread size 1	Mass per 100 mm
Rc1/8	50 g
Rc1/4	80 g
Rc1/2	160 g
Rc3/4	220 g

[Note] Appearance and dimensions may differ slightly depending on materials and nozzle codes.

Spray angle code ⁴	Width	Thick-ness	Spray capacity code	Nozzle thread size 1	Pipe conn. sizes 2, 3	Air pressure (MPa)	Spray capacity (ℓ/min) & Air consumption (ℓ/min, Normal)					Mean droplet dia. (μm)	Free passage dia. (mm)				
							Liquid pressure (MPa)						Immersion sampling method	Fraunhofer diffraction method	Spray tip	Adaptor	
							0.07	0.1	0.2	0.4	0.7					Liquid	Air
125	20	70	70	Rc1/4	Rc1/4	0.1	1.51 / 29	2.22 / 24	—	—	—	200–300	100–150	2.4	2.2	1.5	
						0.2	1.39 / 47	2.02 / 47	3.18 / 45	5.13 / 33	7.07 / 18						
						0.3	1.29 / 63	1.84 / 63	2.92 / 63	4.77 / 55	6.66 / 41						
						0.4	1.19 / 79	1.70 / 79	2.70 / 79	4.42 / 77	6.29 / 64						
110	25	36	36	Rc1/4	Rc1/4	0.1	0.87 / 34	1.20 / 34	1.87 / 31	—	—	200–300	100–150	2.0	1.7	1.5	
						0.2	0.75 / 50	1.10 / 50	1.76 / 49	2.80 / 44	3.70 / 36						
						0.3	0.63 / 66	1.00 / 66	1.66 / 66	2.64 / 64	3.64 / 57						
						0.4	0.50 / 82	0.90 / 82	1.55 / 82	2.50 / 82	3.60 / 76						
	20	50	50	50	Rc1/4	Rc1/4	0.1	1.20 / 46	1.62 / 46	2.72 / 41	—	—	200–300	100–150	2.4	2.0	1.8
							0.2	1.00 / 69	1.47 / 69	2.45 / 65	3.86 / 55	5.13 / 43					
							0.3	0.80 / 92	1.28 / 92	2.17 / 91	2.56 / 85	5.04 / 72					
							0.4	0.60 / 114	1.10 / 114	1.93 / 114	3.30 / 111	4.86 / 99					

DDA series
Secondary Cooling/ Ultra-Thick Flat Spray Nozzles

Spray angle code ⁴		Spray capacity code	Nozzle thread size 1	Pipe conn. sizes 2, 3	Air pressure (MPa)	Spray capacity (ℓ/min) & Air consumption (ℓ/min, Normal)					Mean droplet dia. (μm)		Free passage dia. (mm)		
Width	Thick-ness					Liquid pressure (MPa)					Immersion sampling method	Fraunhofer diffraction method	Spray tip	Adaptor	
						0.07 Liquid / Air	0.1 Liquid / Air	0.2 Liquid / Air	0.4 Liquid / Air	0.7 Liquid / Air				Liquid	Air
100	45	470	Rc3/4	Rc1/2	0.1	8.79 / 220	15.60 / 170	—	—	—	120–350	60–175	6.0	5.8	4.1
					0.2	5.86 / 370	12.20 / 330	20.20 / 280	—	—					
					0.3	3.45 / 490	9.66 / 480	15.50 / 443	32.10 / 285	—					
					0.4	1.21 / 610	7.07 / 610	12.90 / 587	20.70 / 491	46.30 / 240					
	45	580	Rc3/4	Rc1/2	0.1	12.60 / 278	18.80 / 213	—	—	—	140–400	70–200	7.0	6.5	4.7
					0.2	6.87 / 500	12.20 / 462	24.20 / 336	—	—					
					0.3	—	—	17.90 / 550	38.90 / 325	—					
					0.4	—	—	—	32.50 / 535	57.30 / 190					
	15	25	Rc1/8	Rc1/4	0.1	—	—	—	—	—	30–200	15–100	2.0	1.9	1.8
					0.2	—	—	1.05 / 37	—	—					
					0.3	—	—	0.34 / 87	2.20 / 24	—					
					0.4	—	—	—	1.30 / 75	—					
80	20	14	Rc1/4	Rc1/4	0.1	0.36 / 19	0.50 / 19	0.71 / 19	1.11 / 18	1.40 / 17	70–150	35–75	2.0	1.1	1.2
					0.2	0.29 / 29	0.46 / 29	0.68 / 29	1.10 / 28	1.41 / 27					
					0.3	0.22 / 39	0.41 / 39	0.65 / 39	1.08 / 39	1.42 / 37					
					0.4	0.14 / 49	0.37 / 49	0.62 / 49	1.06 / 49	1.43 / 48					
	20	37	Rc1/4	Rc1/4	0.1	0.93 / 33	1.35 / 32	2.02 / 30	3.01 / 24	3.74 / 17	200–300	100–150	2.8	1.7	1.5
					0.2	0.80 / 51	1.23 / 51	1.92 / 50	2.90 / 47	3.74 / 41					
					0.3	0.68 / 68	1.12 / 68	1.83 / 68	2.80 / 65	3.74 / 61					
					0.4	0.57 / 84	1.00 / 84	1.74 / 84	2.72 / 83	3.74 / 80					
	20	50	Rc1/4	Rc1/4	0.1	1.06 / 44	1.70 / 41	2.78 / 32	—	—	200–300	100–150	2.8	2.0	1.8
					0.2	0.86 / 71	1.40 / 70	2.37 / 65	3.79 / 48	4.95 / 35					
					0.3	0.67 / 96	1.18 / 95	2.05 / 92	3.40 / 82	4.84 / 62					
					0.4	0.50 / 121	0.92 / 121	1.68 / 119	3.06 / 111	4.70 / 89					
75	25	230	Rc1/2	Rc1/2	0.1	4.48 / 133	7.03 / 116	—	—	—	120–300	60–150	4.0	4.1	2.9
					0.2	3.50 / 207	5.76 / 199	10.40 / 168	16.20 / 104	—					
					0.3	2.54 / 271	4.58 / 268	9.27 / 249	15.10 / 200	22.30 / 110					
					0.4	1.61 / 330	3.47 / 330	8.33 / 320	14.10 / 278	21.70 / 191					

*4) Criteria for spray angle measurement differs depending on nozzle codes.

Conversion of unit [Pressure] 0.1 MPa ≈ 14.50 psi [Flow rate] 1 ℓ (liter) ≈ 0.26 US gal.
10 psi ≈ 0.07 MPa 1 US gal. ≈ 3.79 ℓ (liter)

How to order

Please inquire or order for a specific nozzle using this coding system.

<Example> 1/4 DDA 1252070 × (70) S303-n

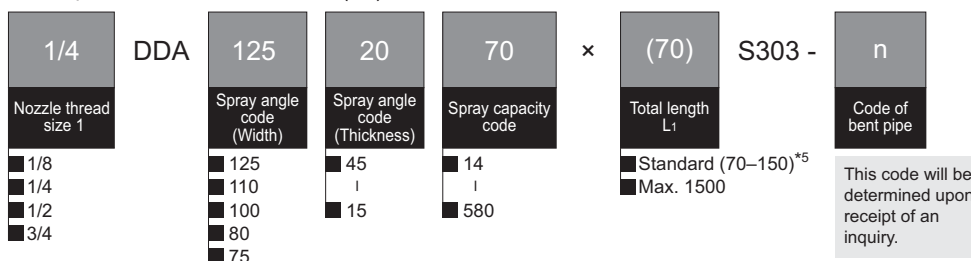

*5) Standard total length differs with nozzle code. See page 19 for dimensions.

DDRP+AS series

Hydraulic/Pneumatic (Dual-use)

Ultra-Thick Even Flat Spray Nozzles

Patented

Steel making process

- Cooling bloom, slab short side, billet
- Roll cooling



FEATURES

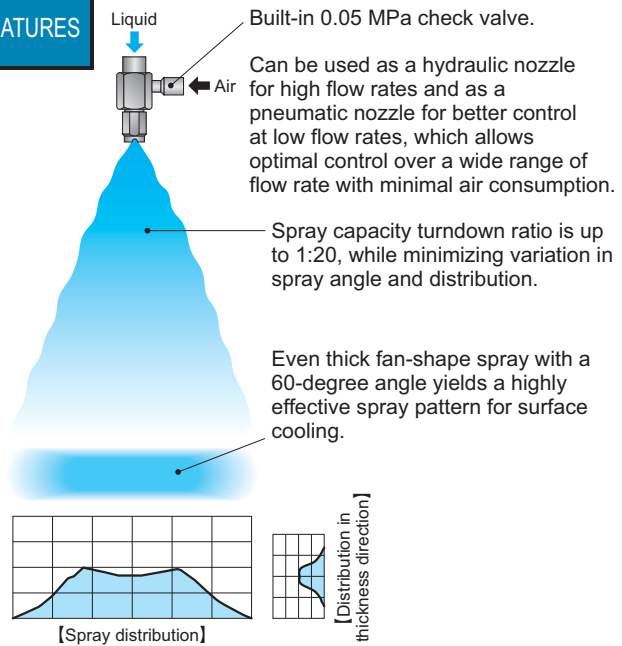

DDRP+AS series

MATERIALS

- ① Nozzle body: S303
- ② Mixing adaptor: S304
- ③ Air socket: S304
- ④ Check valve body: S303
- ⑤ Poppet: S303
- ⑥ Spring: S304
- ⑦ O-ring: NBR

MASS

190 g

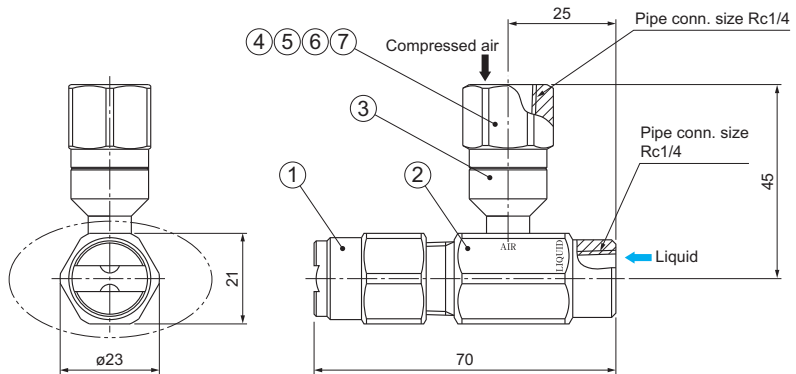

Spray angle code	Spray capacity code	Spray angle (°) in width		Spray angle (°) in thickness		Spray capacity (ℓ/min) & Air consumption (ℓ/min, Normal)*												Mean droplet diameter (μm)	Free pass. dia. (mm)					
		Liquid pressure (MPa)		Liquid pressure (MPa)		Liquid pressure (MPa)													Nozzle	Adaptor				
		0.01 MPa	0.1 MPa	0.3 MPa	1 MPa	0.01 MPa	0.1 MPa	0.3 MPa	1 MPa	0.01	0.02	0.05	0.07	0.1	0.2	0.3	0.5			1	1.5	Liquid	Air	
115	60	200	110	113	115	116	65	58	60	60	1.55 / 29	2.93 / 25	6.81 / 2	9.29 / —	10.9 / —	15.5 / —	19 / —	24.5 / —	34.7 / —	42.5 / —	430-463	2.9	6.7	1.8
		260	110	113	115	116	65	58	60	60	2.01 / 38	3.81 / 33	8.86 / 3	12.1 / —	14.2 / —	20.1 / —	24.7 / —	31.9 / —	45.1 / —	55.3 / —		3.3	7.6	2.0
90	60	200	86	89	90	90	65	58	60	60	1.55 / 29	2.93 / 25	6.81 / 2	9.29 / —	10.9 / —	15.5 / —	19 / —	24.5 / —	34.7 / —	42.5 / —	455-488	2.9	6.7	1.8
		260	86	89	90	90	65	58	60	60	2.01 / 38	3.81 / 33	8.86 / 3	12.1 / —	14.2 / —	20.1 / —	24.7 / —	31.9 / —	45.1 / —	55.3 / —		3.4	7.6	2.0

*Air consumption measured at compressed air pressure of 0.1 MPa

Conversion of unit [Pressure] 0.1 MPa ≈ 14.50 psi [Flow rate] 1 ℓ (liter) ≈ 0.26 US gal. 10 psi ≈ 0.07 MPa 1 US gal. ≈ 3.79 ℓ (liter)

How to order

Please inquire or order for a specific nozzle using this coding system.

<Example> DDRP 11560 200 S303 + 1/4F×1/4F AS S304

DDRP 115 60 200 S303+ 1/4F × 1/4F AS S304

Spray angle code (width)

- 115
- 90

Spray capacity code

- 200
- 260

DDR+AS series
Hydraulic/Pneumatic (Dual-use) Ultra-Thick Even Flat Spray Nozzles

Turndown ratio range of DDRP+AS series nozzles

Turndown ratio range of normal hydraulic spray nozzles at maximum pressure is limited by pump capacity, and at minimum pressure it is limited by narrower spray angle and unstable spray condition. When the max liquid pressure of water is 0.9 MPa, the turndown ratio of normal hydraulic spray nozzles is 1:4–4.5.

DDR+AS series can keep stable spray at very low flow due to air pressure. When the maximum liquid pressure is 0.9 MPa, turndown ratio can be extended to 1:20.

Large ↑ Spray capacity ↓ Small	Spray capacity (ℓ/min)	Liquid pressure (MPa)	Air pressure (MPa)	Air consumption (ℓ/min, Normal)	Width	Thickness
	A	33	0.9	0.1	0	
B	19	0.3	0.1	0		
C	1.55	0.01	0.1	29		

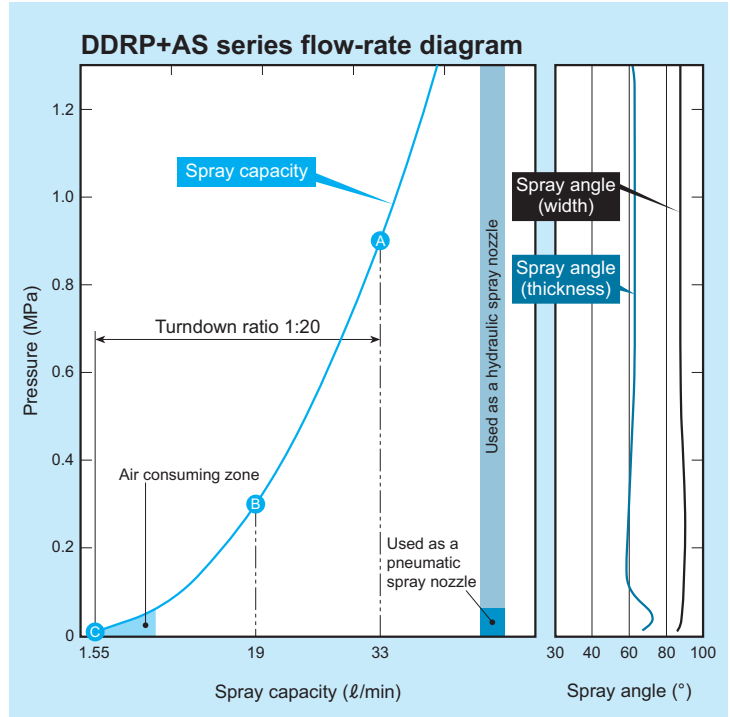

Turndown ratio range of hydraulic spray nozzle

Turndown ratio range of hydraulic spray nozzles at maximum pressure is limited by pump capacity, and at minimum pressure it is limited by narrower spray angle and unstable spray condition.

When the maximum liquid pressure is 0.6 MPa, the turndown ratio of hydraulic nozzle is 1:2.5–3.5.

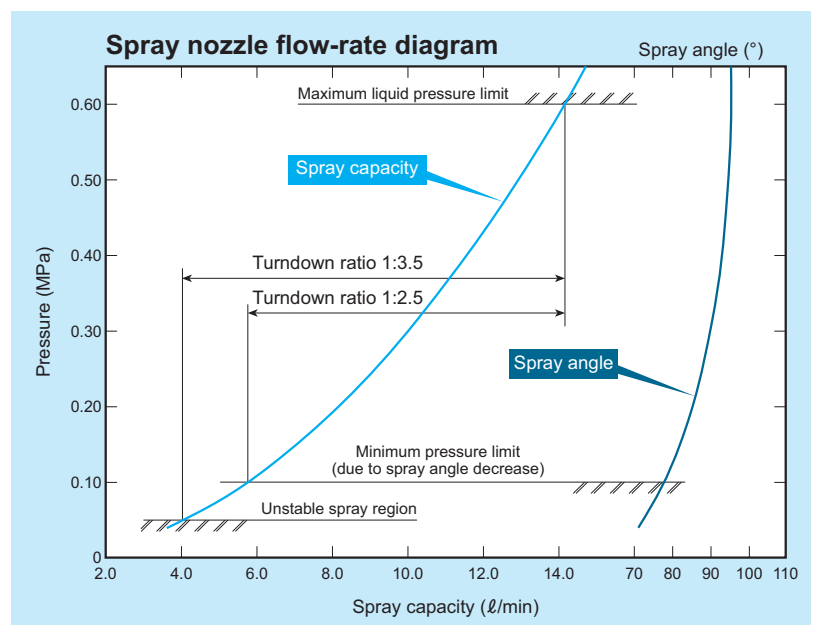

VVP+AS series

Hydraulic/Pneumatic (Dual-use) Flat Spray Nozzles

Patented

Steel making process

- Cooling bloom, slab short side, billet
- Roll cooling

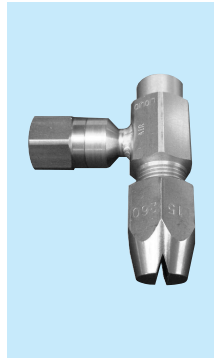

FEATURES

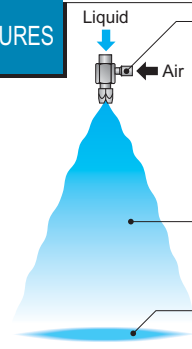

- Built-in 0.05 MPa check valve.
- Can be used as a hydraulic nozzle for high flow rates and as a pneumatic nozzle for better control at low flow rates, which allows optimal control over a wide range of flow rate with minimal air consumption.
- Spray capacity turndown ratio is up to 1:20, while minimizing variation in spray angle and distribution.
- Normal flat spray pattern with mountain-shaped distribution.

VVP+AS series

MATERIALS

- ① Nozzle body: S303
- ② Mixing adaptor: S304
- ③ Air socket: S304
- ④ Check valve body: S303
- ⑤ Poppet: S303
- ⑥ Spring: S304
- ⑦ O-ring: NBR

MASS

Approx. 200 g

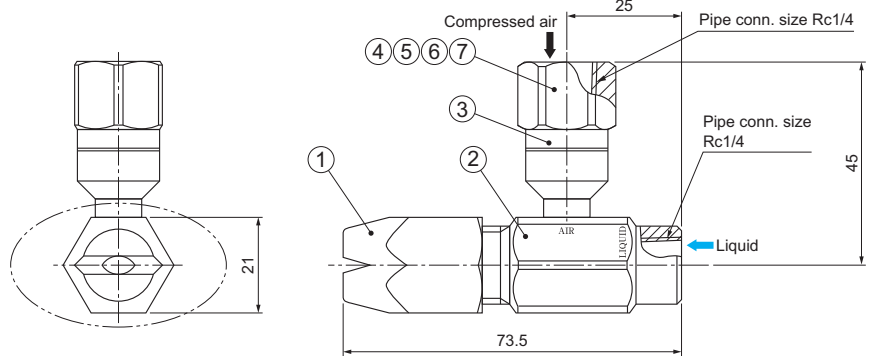

Spray angle code	Spray capacity code	Spray angle (°)		Spray capacity (ℓ/min) & Air consumption (ℓ/min, Normal)*																Mean droplet diameter (μm)	Free pass. dia. (mm)		
				Liquid pressure (MPa)																	Nozzle	Adaptor	
		0.01 MPa	0.1 MPa	0.3 MPa	0.7 MPa	0.01 Liquid / Air	0.02 Liquid / Air	0.03 Liquid / Air	0.05 Liquid / Air	0.07 Liquid / Air	0.1 Liquid / Air	0.15 Liquid / Air	0.2 Liquid / Air	0.3 Liquid / Air	0.5 Liquid / Air	0.7 Liquid / Air	1 Liquid / Air	1.5 Liquid / Air	2 Liquid / Air			Liquid	Air
100	—	107	115	119	—	—	0.94 / 35	2.96 / 10	4.83 / —	5.69 / —	6.97 / —	8.05 / —	9.87 / —	12.8 / —	15.1 / —	18.1 / —	22.1 / —	25.6 / —	400-550	1.4	—		
200	100	107	115	119	1.55 / 46	2.93 / 40	4.26 / 30	6.81 / 4	9.29 / —	10.9 / —	13.4 / —	15.5 / —	19 / —	24.5 / —	29.0 / —	34.7 / —	42.5 / —	49.1 / —	400-550	2.4	—		
115	230	100	107	115	119	1.78 / 46	3.37 / 40	4.89 / 30	7.84 / 4	10.7 / —	12.6 / —	15.4 / —	17.8 / —	21.8 / —	28.2 / —	33.4 / —	39.9 / —	48.9 / —	56.5 / —	400-550	2.7	7.0	2.0
260	100	107	115	119	2.01 / 46	3.81 / 40	5.53 / 30	8.86 / 3	12.1 / —	14.2 / —	17.4 / —	20.1 / —	24.7 / —	31.9 / —	37.7 / —	45.1 / —	55.3 / —	63.9 / —	400-550	2.8	—		
300	100	107	115	119	2.28 / 46	4.32 / 40	6.28 / 30	10.1 / 4	13.7 / —	16.1 / —	19.8 / —	22.8 / —	28 / —	36.2 / —	42.8 / —	51.2 / —	62.8 / —	72.5 / —	400-550	3.0	—		

*Air consumption measured at compressed air pressure of 0.1 MPa

Conversion of unit [Pressure] 0.1 MPa ≈ 14.50 psi [Flow rate] 1 ℓ (liter) ≈ 0.26 US gal. 10 psi ≈ 0.07 MPa 1 US gal. ≈ 3.79 ℓ (liter)

Comparison of distribution of VVP+AS series

■ Large spray flow (Used as a hydraulic spray nozzle)

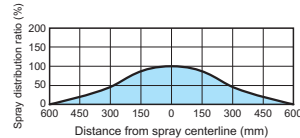

Spray condition

- Spray capacity: 51.2 ℓ/min
- Liquid pressure: 1 MPa
- Air consumption: 0
- Compressed air pressure: 0.1 MPa
- Spray height: 400 mm

■ Low spray flow (Used as a pneumatic spray nozzle)

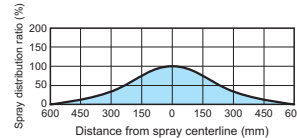
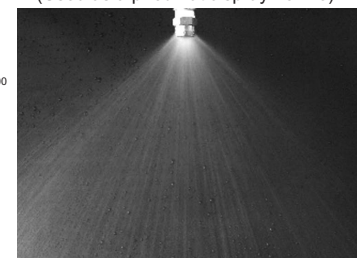

Spray condition

- Spray capacity: 6.28 ℓ/min
- Liquid pressure: 0.03 MPa
- Air consumption: 30 ℓ/min, Normal
- Compressed air pressure: 0.1 MPa
- Air-water ratio: 3.4
- Spray height: 400 mm

How to order

Please inquire or order for a specific nozzle using this coding system.

<Example> VVP 115 100 S303 + 1/4F×1/4F AS S304

VVP115

100

Spray capacity code

- 100
- 200
- 230
- 260
- 300

S303 + 1/4F × 1/4F AS S304

BIM series Small Capacity Fine Fog Nozzles

Raw material process

- Dust suppression on raw material conveyor line
- Spraying reducing agents for denitration

Steel making process

- Cooling electrodes of electric furnace
- Roll cooling

Rolling mill process

- Coil cooling

Surface finish

- Minimized spangle treatment of continuous galvanized steel
- Cooling steel plates after coating



Photo of BIMV flat spray

FEATURES

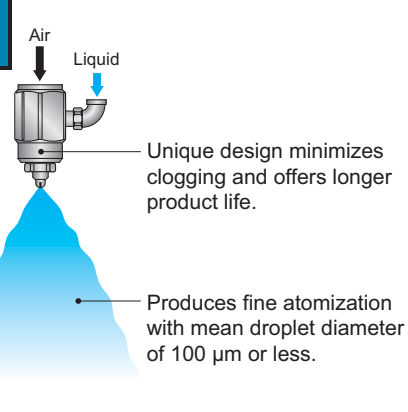

Spray patterns in three types

BIMV Flat spray

[FEATURES]

- Flat spray pneumatic nozzle producing fine atomization with mean droplet diameter of 100 μm or less.*1
- When spraying at a low air-water ratio, BIMV nozzle produces uniform spray distribution. At a high air-water ratio, it produces a mountain-shaped distribution, but a uniform distribution can be achieved by using a multiple nozzle alignment.
- Three spray angles of 45°, 80°, and 110° are available.
- Eight types of adaptors are available.

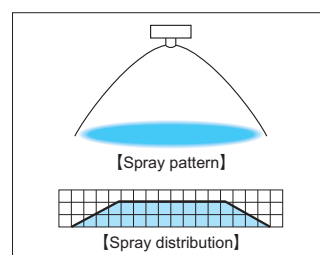

BIMK Hollow cone spray

[FEATURES]

- Hollow cone spray pneumatic nozzle producing fine atomization with mean droplet diameter of 100 μm or less.*1
- Spray angle is 60°.
- Eight types of adaptors are available.

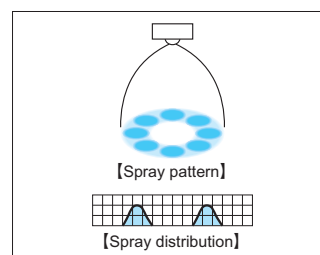

BIMJ Full cone spray

Patented

[FEATURES]

- Full cone spray pneumatic nozzle producing fine atomization with mean droplet diameter of 100 μm or less.*1
- Two spray angles of 20° and 70° are available.
- Eight types of adaptors are available.

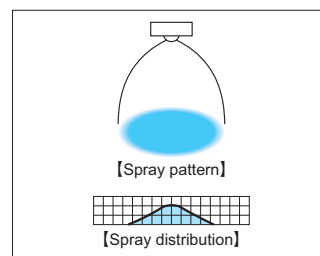

*1) Droplet diameter measured by laser Doppler method

■ Main material of BIM series is S303.

■ Spray angle and spray capacity code

■ Operating pressure: Air pressure = 0.2–0.4 MPa, Liquid pressure = 0.1–0.3 MPa

Series (Spray pattern)	Spray angle code	Air consumption code				
		02	04	075	15	22
BIMV (Flat spray)	110	○	○	○	○	○
	80	○	○	○	○	○
	45	○	○	○	○	○
BIMK (Hollow cone spray)	60	△	○	○	○	○
BIMJ (Full cone spray)	70	△	○	○	○	○
	20	○	○	○	○	○
Spray capacity range (ℓ/hr)		1–10	2–20	4–40	8–80	11–110
Air consumption per nozzle (ℓ/min, Normal)	Air pressure = 0.2 MPa	15	27	54	113	150
	Air pressure = 0.3 MPa	20	36	74	150	220
	Air pressure = 0.4 MPa	25	46	94	190	250

Note: Nozzle description should be indicated as, e.g. "BIMV11002S303+...". Please see **How to order** on page 26.

Conversion of unit [Pressure] 0.1 MPa ≈ 14.50 psi [Flow rate] 1 ℓ (liter) ≈ 0.26 US gal.
10 psi ≈ 0.07 MPa 1 US gal. ≈ 3.79 ℓ (liter)

**BIM series
Small Capacity Fine Fog Nozzles**

Types of adaptors and features

Type T

Air inlet is on the center line and liquid inlet is on a 90° angle line to the center line. Suitable for use in a small space.

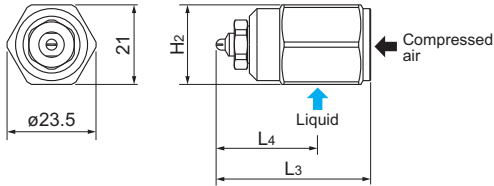

Type N

Liquid and air enter into adaptor from both sides.

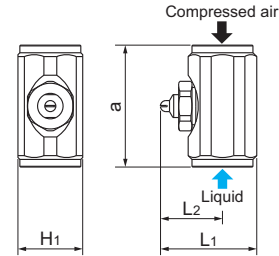

Type NDB

Spray capacity is adjustable with needle valve.

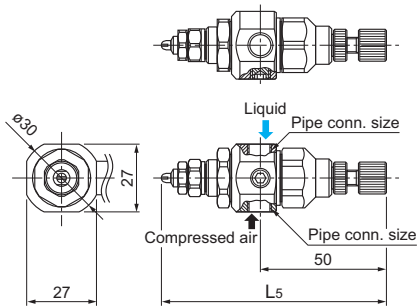

Type SPB

Spray ON/OFF can be regulated by switching the pilot air ON/OFF. The pilot air actuates an internal piston to regulate the spray. (Pilot air pressure more than 0.2 MPa required)

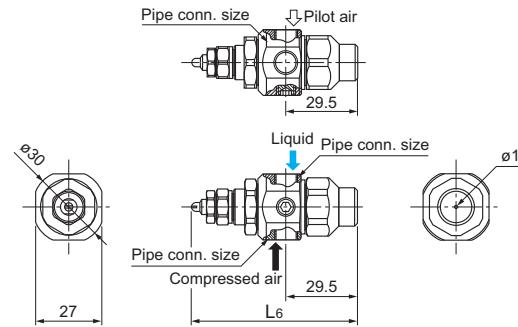

Type SNB

Spray can be regulated by turning compressed air ON/OFF, which actuates an internal piston, to open or close the nozzle. (Compressed air pressure over 0.2 MPa starts the spray.)

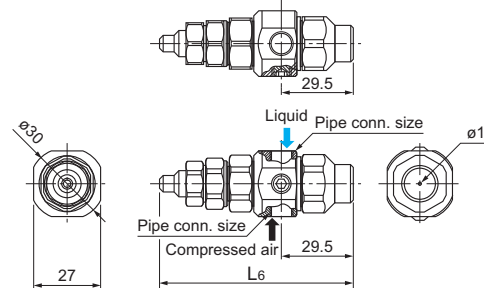

Ball joint type adaptor



- Spray direction can be adjusted within +/- 15° by means of a ball joint.
- It is ideal for fine-tuning of spray direction after pipe assemblies have been completed.
- Ball joint types are UNDB, USPB, and USNB adaptors. (e.g., UNDB = NDB-type adaptor including a ball joint)

Air consumption code	Dimensions (mm)								
	L1	L2	L3	L4	L5	L6	a	H1	H2
02	25.3	16.3	40.8	24.8	87.3	66.8	32	17	21
04	26.8	17.8	42.3	26.3	88.8	68.3	32	17	21
BIMJ 2004	27.0	18.0	42.5	26.5	89.0	68.5	32	17	21
075	28.1	19.1	43.6	27.6	90.1	69.6	32	17	21
15	39.1	26.6	60.1	38.1	97.8	77.1	43	23	29
22	41.3	28.8	62.3	40.3	99.8	79.3	43	23	29

Pipe connection size and Mass

Adaptor	Air consumption code	Pipe connection size			Mass (g)
		Compressed air	Liquid	Pilot air	
N	02,04,075	Rc1/8	Rc1/8		55
	15,22	Rc1/4	Rc1/4		130
T	02,04,075	Rc1/8	Rc1/8		80
	15,22	Rc1/4	Rc1/4		210
NDB (UNDB)	02,04,075	Rc1/8	Rc1/8		172
	15,22				193
SPB (USPB)	02,04,075	Rc1/8	Rc1/8	Rc1/8	146
	15,22				167
SNB (USNB)	02,04,075	Rc1/8	Rc1/8		151
	15,22				172

How to use BIM controlling adaptors

■ SPB adaptor

Spray (ON/OFF) can be regulated by switching the pilot air ON/OFF. The pilot air actuates an internal piston to regulate the spray. The pilot air pressure must be 0.2 MPa or higher. As even low pressure atomizing air can be used, production of a range of fine to coarse fog is possible. Best-suited for when there is concern about scattering droplets.

Connection example

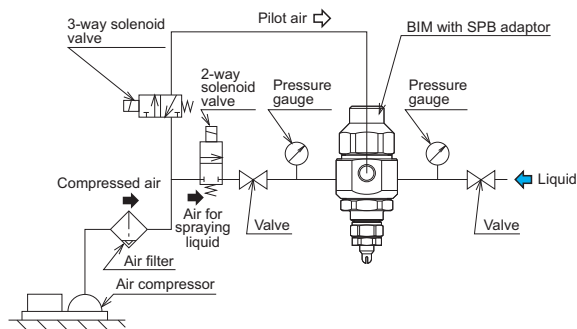

Function chart

Compressed air		ON		
Pilot air	OFF	ON	OFF	ON
Liquid	Stop	Spray	Stop	Spray

■ SNB adaptor

Spray (ON/OFF) can be regulated by turning compressed air ON/OFF. Compressed air pressure must be 0.2 MPa or higher in order to start the spray.

Connection example

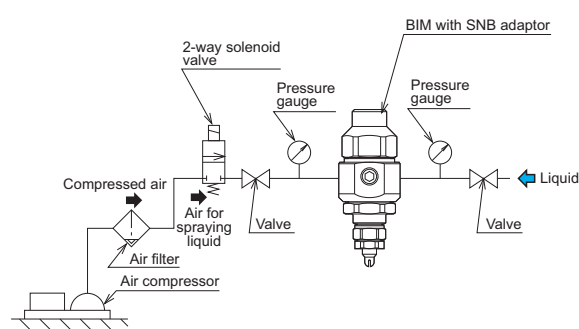

Function chart

Compressed air	OFF	ON	OFF	ON	OFF
Liquid	Stop	Spray	Stop	Spray	Stop

Optional product

■ Mounting bracket (MBW)

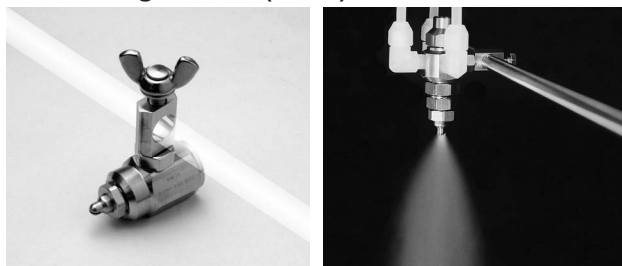

Mounting bracket enables easy fixing of a nozzle on a pole with desired spray direction. Available in two size for pipe diameters of 8 mm and 10 mm. Available for the adaptor types T, NDB, UNDB, SPB, USPB, SNB, and USNB (not available for N-type adaptor).

How to order

Please inquire or order for a specific nozzle using this coding system.

<Example> BIMV 110 02 S303 + N S303

BIM	V	110	02	S303	+	N	S303
	Spray pattern	Spray angle code	Air consumption code			Type of adaptor	
	■ V (Flat spray)	■ 110	■ 02			■ N	
	■ K (Hollow cone spray)	■ 80	■ 04			■ T	
	■ J (Full cone spray)	■ 70	■ 075			■ NDB	
		■ 60	■ 15			■ UNDB	
		■ 45	■ 22			■ SPB	
		■ 20				■ USPB	
						■ SNB	
						■ USNB	

BIM Header

Integrated Spray Header with BIM Fine Fog Nozzles

- Iron making process**
 - Cooling refractories of hot metal runner
- Steel making process**
 - Cooling ladle and tundish at maintenance
- Rolling mill process**
 - Cold rolled sheets wetting processing
- Surface finish**
 - Minimized spangle treatment of continuous galvanized steel
 - Cooling for CGL sheets after alloying furnace
 - Fog cooling for EGL sheets

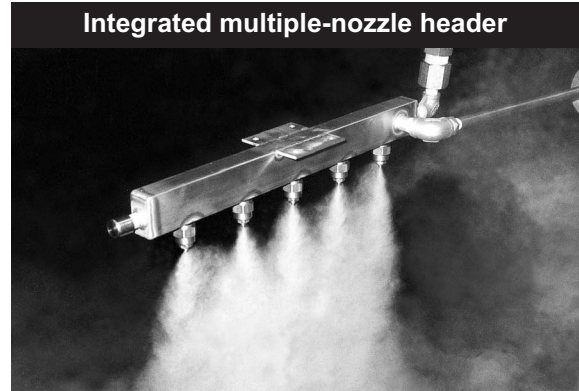

FEATURES

Spray header equipped with BIMV nozzles producing fine atomization with mean droplet diameter of 100 μm or less.*1

Uniform spray distribution across the entire spray area.

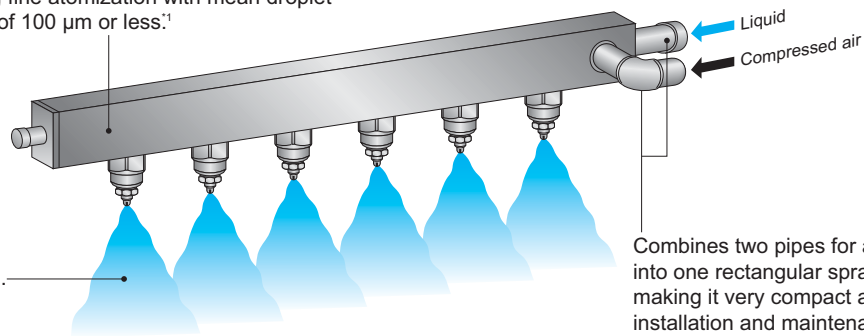

*1) Droplet diameter measured by laser Doppler method

BIM spray header used for minimized spangle

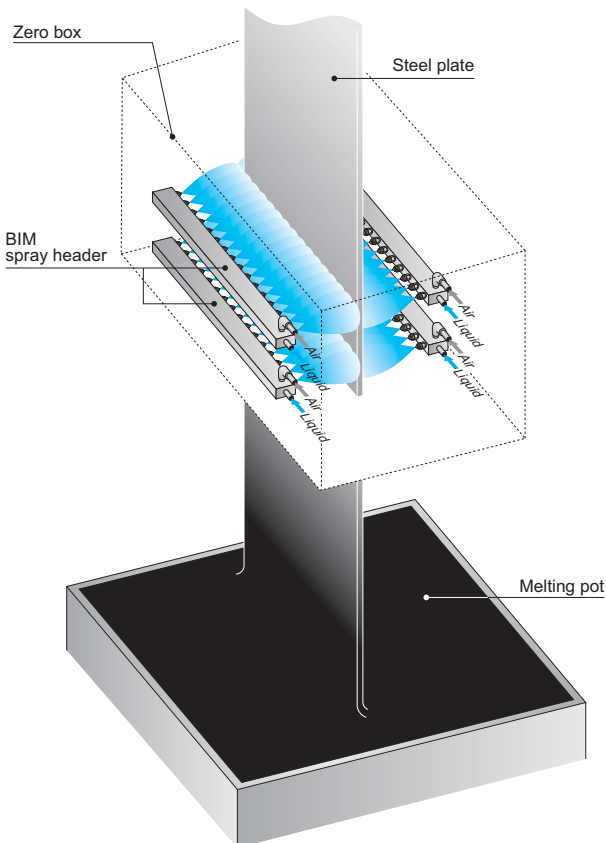

BIM nozzle, which atomizes surface treatment liquid, can be sprayed on steel plates effectively and uniformly at high speed. Unique design of BIM nozzles minimizes clogging and achieves long-time continuous spray.

Clogging comparison in pneumatic spray nozzles

Test conditions

Pa: Compressed air pressure, Pw: Liquid pressure

- ★ BIM nozzle: Pa=0.3 MPa, Pw=0.26 MPa, Spray capacity=15 ℓ/hr
 - Competitor's nozzle A: Pa=0.3 MPa, Pw=0.28 MPa, Spray capacity=15 ℓ/hr
 - Competitor's nozzle B: Pa=0.3 MPa, Pw=0.22 MPa, Spray capacity=15 ℓ/hr
- Used liquid: Excel 601, 10% dilution Continuous spraying

Test results

The figure below shows the change in the spray capacity after spraying for 50 hours.

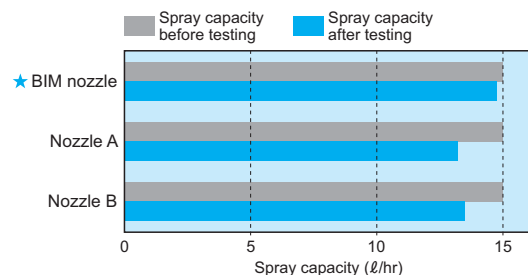

Standard specifications of rectangular spray header with BIM nozzles

■ Air/Liquid inlet position [Type A]

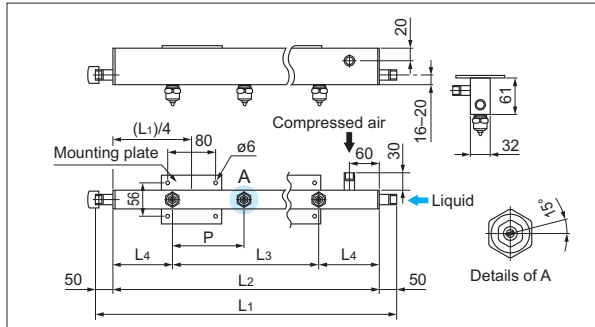

■ Air/Liquid inlet position [Type B]

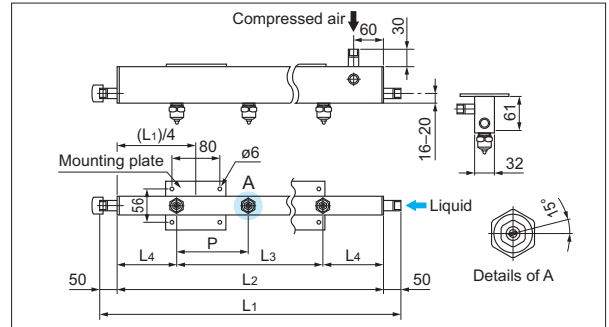

Header code		Nozzle spacing P (mm)	Nozzle Qty. (pcs.)	Spacing (mm)		Pipe connection size						Material	
Header length L2 (mm)	Total length L1 (mm)			L3	L4	BIMV11002		BIMV11004		BIMV110075		Nozzle	Header
1,000	1,100	100	10	900	50	R3/8	R1/4	R3/8	R1/4	R1/2	R3/8	S303	S304
		200	5	800	100					R3/8	R1/4		
2,000	2,100	100	20	1,900	50	R1/2	R3/8	R1/2	R3/8	R3/4	R1/2		
		200	10	1,800	100	R3/8	R1/4	R3/8	R1/4	R1/2	R3/8		

■ Mounting plate [Type: F, S, or None]

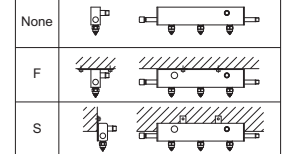

F: To install facing perpendicular from a wall.
S: To install facing parallel along a wall edge.

Specifications of BIMV6006Z nozzle for zero/minimized spangle

● Flow-rate diagram

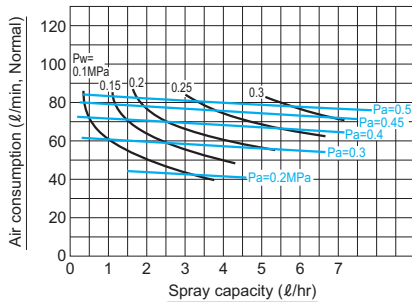

■ How to read chart

- The above spray capacity shown is for one nozzle.
- Black lines (—) represent liquid pressures Pw in MPa.
- Blue lines (—) represent compressed air pressures Pa in MPa.

● Spray distribution

[Spray conditions] Compressed air pressure: 0.4 MPa, Liquid pressure: 0.2 MPa, Spray height: 50 mm

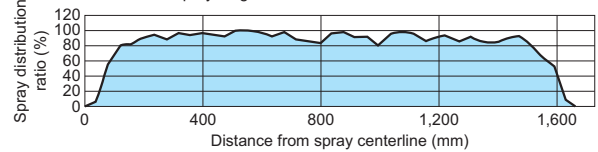

● Spray impact distribution

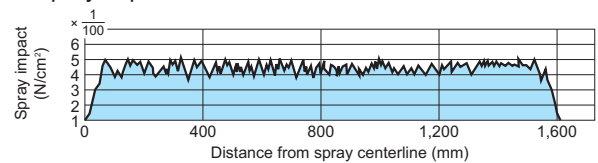

● Drawing

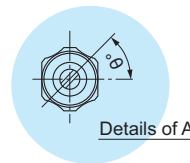
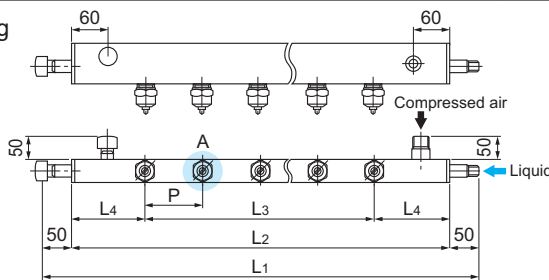

- P: Nozzle spacing
- L1: Total length
- L2: Length of rectangular spray header
- L3: Distance between nozzles of both ends
- L4: Distance to nozzle from the end of header
- θ: Offset angle (nozzle tip angle to axis of header)

How to order

To determine specifications, please specify a nozzle code, nozzle quantity, nozzle spacing, and header length etc., using this coding system.

<Example> BIMV 11002 S303 + 10 (P100) A1000F (Pre-setting 15°, L=1100)

BIMV11002	S303	+	10	(P 100)	A	1000	F	(Pre-setting 15°, L= 1100)	
Nozzle code			Nozzle quantity	Nozzle spacing	Inlet position type	Header length	Mounting plate type	Offset angle, Total length	
■ BIMV11002			■ 5	■ 100	■ A	■ 1000	■ F	■ 0°	■ 1100
■ BIMV11004			■ 10	■ 200	■ B	■ 2000	■ S	■ 15°	■ 2100
■ BIMV110075			■ 20				■ (None)	(Blank denotes 0°.)	

Note: Inquire with us for integrated spray header for zero/minimized spangle control.

GSIMII series

Large Capacity Fine Fog Nozzles

Iron making process

- Gas cooling before turbine
- Cooling refractories of torpedo car before maintenance
- Dust suppression at casting of pig iron

Steel making process

- Cooling converter shell at maintenance
- Cooling flue gas from electric furnace
- Dust suppression at casting of steel

Rolling/ Surface finish

- Cooling flue gas from heating furnace
- Dust suppression at rolling mill outlet

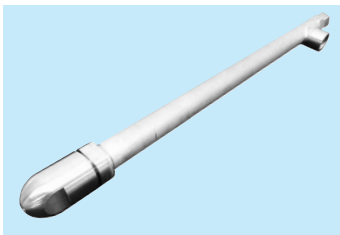

FEATURES

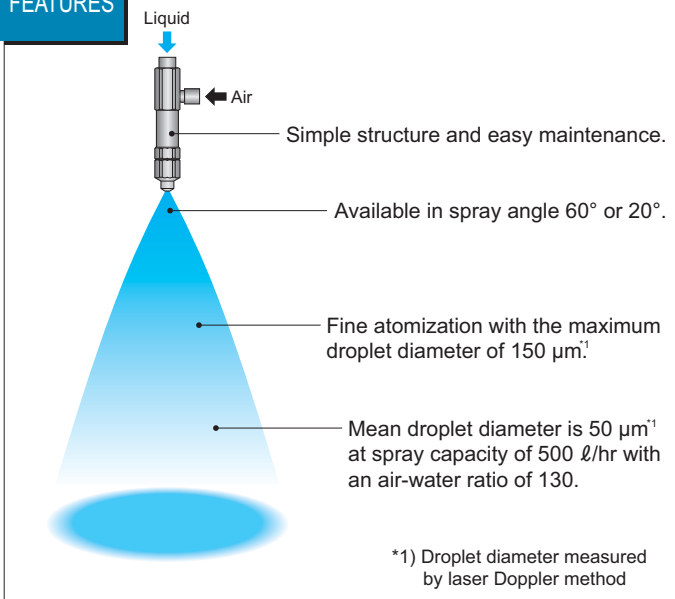

GSIMII series

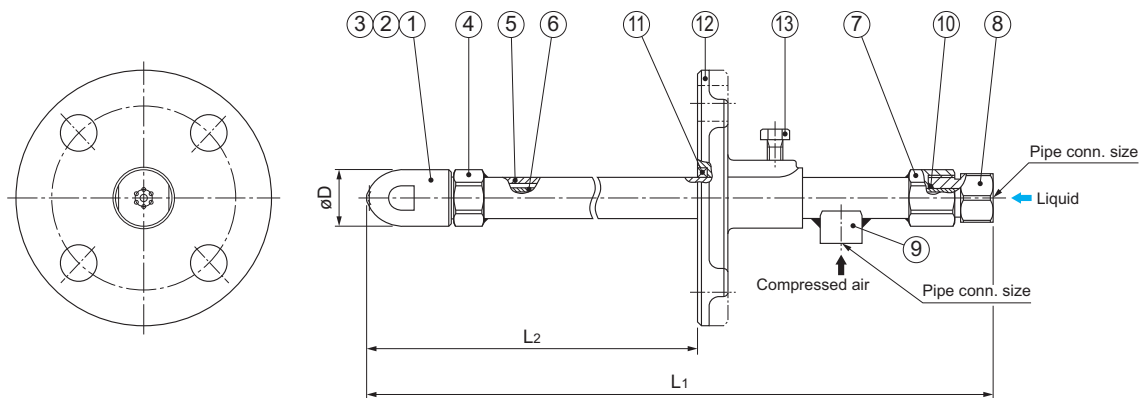

MATERIALS

- ① Nozzle tip: S316L
- ② Nozzle core: S316L
- ③ Whirler: S316L equivalent
- ④ Nozzle adaptor: S316L
- ⑤ Outer pipe (for air): S316L
- ⑥ Inner pipe (for liquid): S304
- ⑦ Joint: S304
- ⑧ Liquid socket: S304
- ⑨ Air socket: S304
- ⑩ O-ring: FKM
- ⑪ Packing: Metal wire reinforced AES wool
- ⑫ Flange: SCS13 (S304)
- ⑬ Bolt: S304

Dimensions

Spray angle code	Air consumption code	Pipe connection sizes		Outer diameter (øD)	Free passage diameter (mm)	
		Air	Liquid		Liquid ²	Air
60 20	37	Rc3/8	Rc3/8	30	1.8 (2.2)	1.6
	55				2.2 (2.2)	2.0
	75	Rc1/2	Rc1/2	38	2.6 (3.2)	2.3
	110				3.2 (3.2)	2.9
	150	Rc3/4	Rc1/2	50	3.7 (4.0)	3.3
	220				4.0 (4.0)	4.0

*2) Free passage diameter in () shows that of GSIMII with spray angle code of 20.

Type of length

Type	Total length L ¹ (mm)	Length L ₂ (mm)
A	560	300-400
B	760	400-600
C	960	600-800
D	1,160	800-1,000

*3) L₁: Standard length

Mass

Air consumption code	Length type	Mass (g) ⁴
37, 55	A	1,300
	B	1,600
	C	2,000
	D	2,400
75, 110	A	1,800
	B	2,300
	C	2,800
	D	3,300
150, 220	A	2,500
	B	3,100
	C	3,700
	D	4,300

*4) The mass shown is when the total length is the standard length L₁ and excludes a mass of flange. For longer lengths, add the corresponding mass for each 100 mm of length as below.
(Air consumption code: Mass per 100 mm)
37/55: 180 g, 75/110: 260 g, 150/220: 300 g

GSIMII Flow-rate diagrams (Spray angle 60° type)

- The spray capacity shown is for one nozzle.
- Blue lines represent compressed air pressures P_a in MPa, solid black lines represent liquid pressures P_w in MPa, and dotted lines represent air-water ratio Q_a/Q_w .
- Figures in ovals \bigcirc indicate Sauter mean droplet diameters (μm) measured by laser Doppler method.

Conversion of unit [Pressure] 0.1 MPa \approx 14.50 psi [Flow rate] 1 ℓ (liter) \approx 0.26 US gal.
10 psi \approx 0.07 MPa 1 US gal. \approx 3.79 ℓ (liter)

GSIM6037II

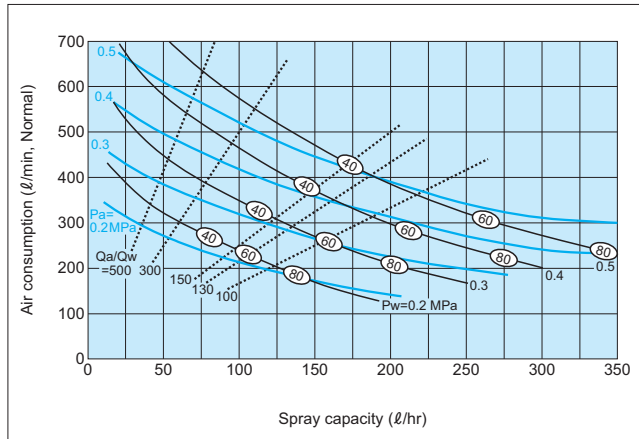

GSIM60110II

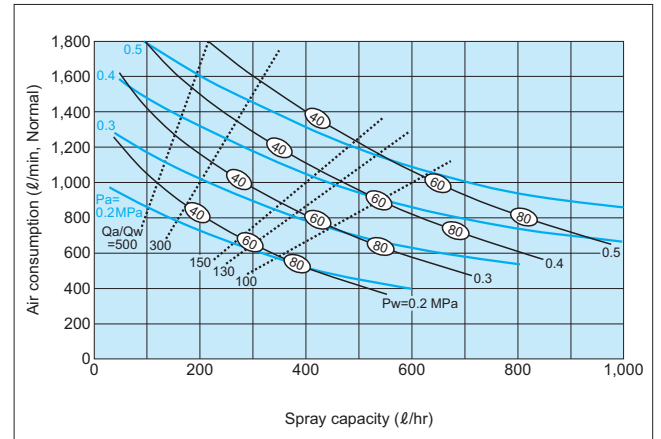

GSIM6055II

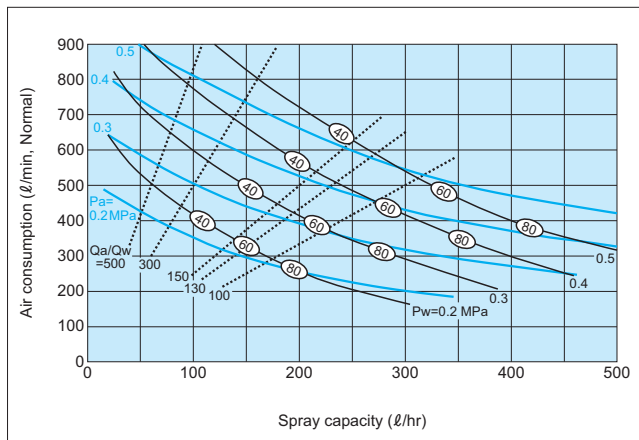

GSIM60150II

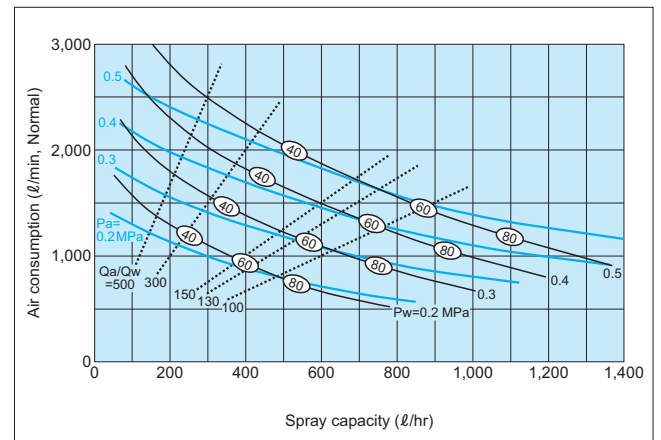

GSIM6075II

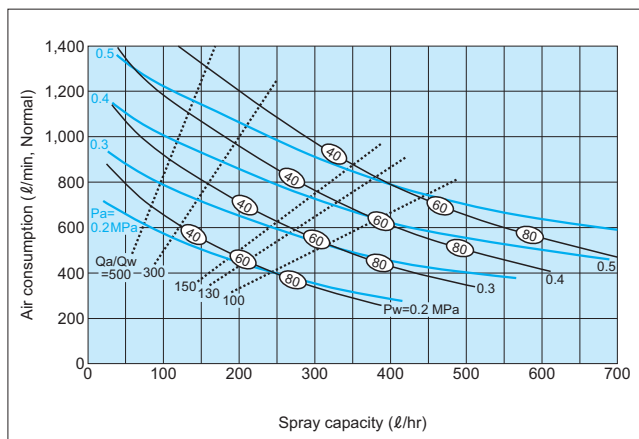

GSIM60220II

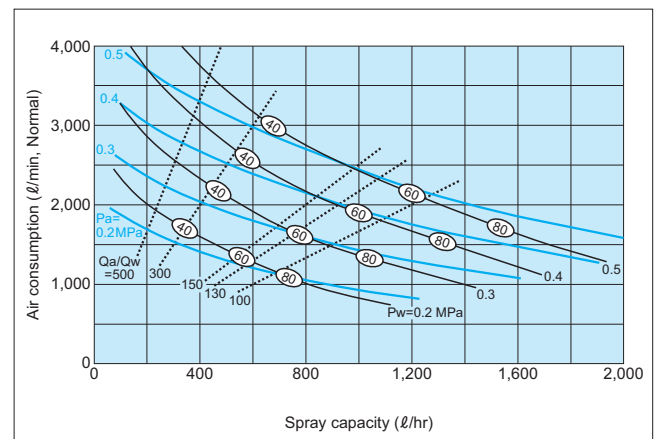

**GSIMII series
Large Capacity Fine Fog Nozzles**

GSIMII Flow-rate diagrams (Spray angle 20° type)

- The spray capacity shown is for one nozzle.
- Blue lines represent compressed air pressures P_a in MPa, solid black lines represent liquid pressures P_w in MPa, and dotted lines represent air-water ratio Q_a/Q_w .
- Figures in ovals ○ indicate Sauter mean droplet diameters (μm) measured by laser Doppler method.

Conversion of unit [Pressure] 0.1 MPa \approx 14.50 psi [Flow rate] 1 ℓ (liter) \approx 0.26 US gal.
10 psi \approx 0.07 MPa 1 US gal. \approx 3.79 ℓ (liter)

GSIM2037II

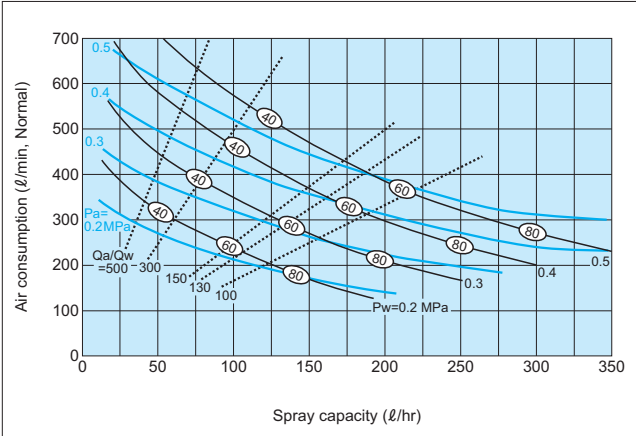

GSIM20110II

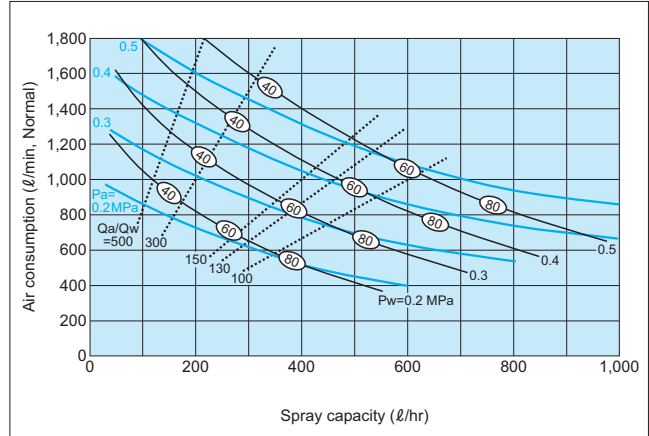

GSIM2055II

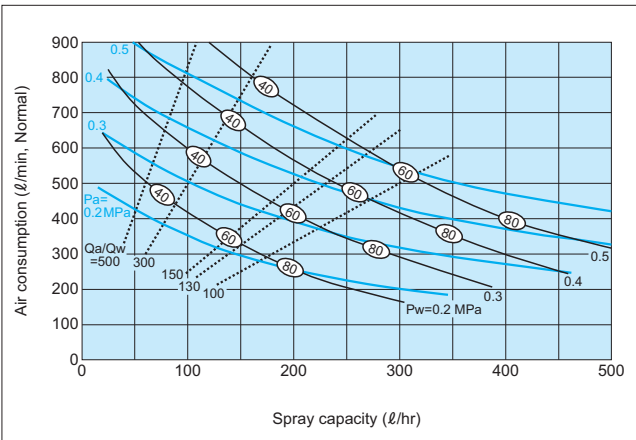

GSIM20150II

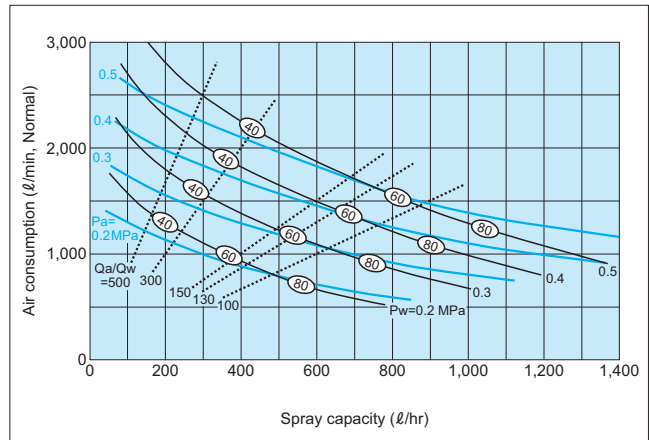

GSIM2075II

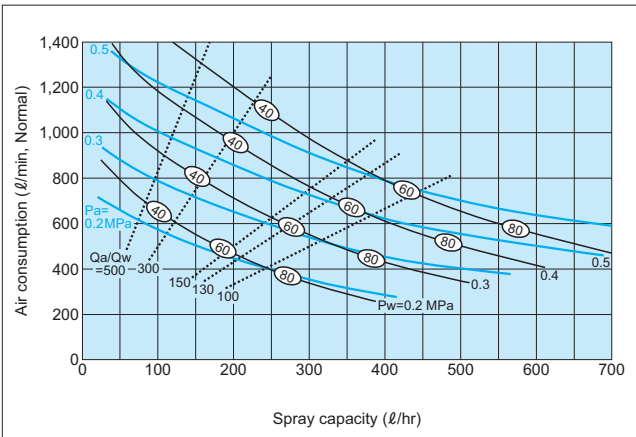

GSIM20220II

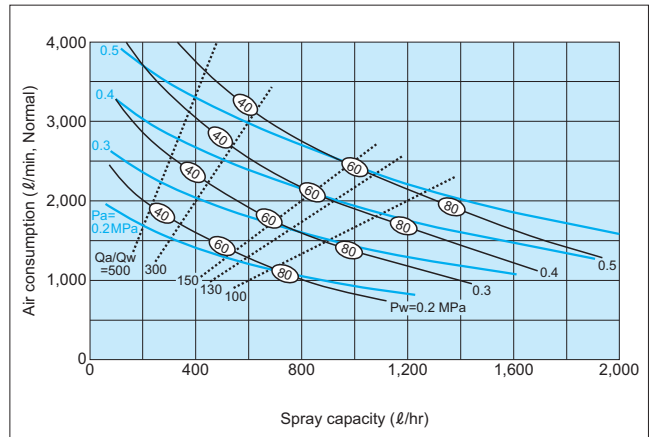

GSIMII Spray dimensions

● Spray dimensions

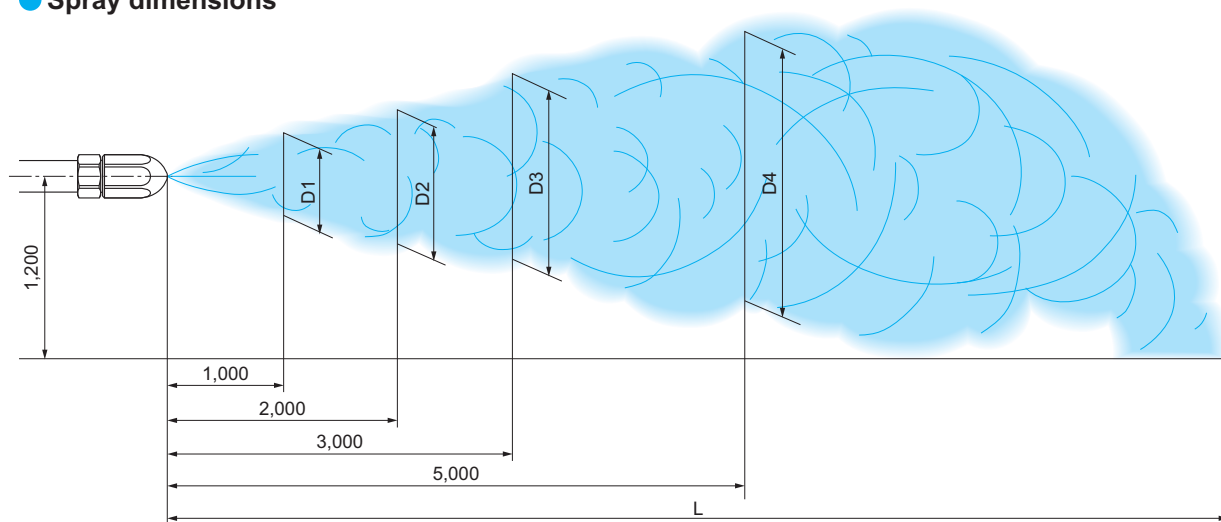

Spray angle code	Air consumption code	Air pressure (MPa)	Liquid pressure (MPa)	Spray dimensions (mm)				
				D1	D2	D3	D4	L
60	37	0.3	0.25-0.30	600	950	1,200	1,700	8,000
			0.30-0.35	700	1,050	1,350	1,700	8,000
		0.4	0.35-0.40	550	850	1,100	1,700	8,000
			0.40-0.45	650	950	1,250	1,700	8,000
		0.5	0.45-0.50	500	800	1,000	1,700	8,000
			0.50-0.55	600	900	1,150	1,700	8,000
	55	0.3	0.25-0.30	650	1,000	1,250	1,800	9,000
			0.30-0.35	750	1,100	1,400	1,800	9,000
		0.4	0.35-0.40	600	900	1,150	1,800	9,000
			0.40-0.45	650	1,000	1,300	1,800	9,000
		0.5	0.45-0.50	500	850	1,050	1,800	9,000
			0.50-0.55	600	950	1,200	1,800	9,000
	75	0.3	0.25-0.30	700	1,050	1,300	1,900	10,000
			0.30-0.35	800	1,150	1,450	1,900	10,000
		0.4	0.35-0.40	650	950	1,200	1,900	10,000
			0.40-0.45	700	1,050	1,350	1,900	10,000
		0.5	0.45-0.50	550	900	1,100	1,900	10,000
			0.50-0.55	600	1,000	1,250	1,900	10,000
	110	0.3	0.25-0.30	750	1,100	1,400	1,900	10,000
			0.30-0.35	850	1,200	1,500	1,900	10,000
		0.4	0.35-0.40	700	1,050	1,300	1,900	11,000
			0.40-0.45	750	1,150	1,450	1,900	11,000
		0.5	0.45-0.50	600	1,000	1,200	1,900	11,000
			0.50-0.55	650	1,100	1,350	1,900	11,000
150	0.3	0.25-0.30	800	1,150	1,500	2,000	11,000	
		0.30-0.35	900	1,250	1,600	2,000	11,000	
	0.4	0.35-0.40	750	1,100	1,400	2,000	12,000	
		0.40-0.45	800	1,200	1,500	2,000	12,000	
	0.5	0.45-0.50	650	1,050	1,300	2,000	12,000	
		0.50-0.55	700	1,150	1,400	2,000	12,000	
220	0.3	0.25-0.30	900	1,200	1,600	2,100	11,000	
		0.30-0.35	950	1,300	1,700	2,100	11,000	
	0.4	0.35-0.40	800	1,150	1,500	2,100	12,000	
		0.40-0.45	850	1,250	1,600	2,100	12,000	
	0.5	0.45-0.50	700	1,100	1,400	2,100	12,000	
		0.50-0.55	750	1,200	1,500	2,100	12,000	

Spray angle code	Air consumption code	Air pressure (MPa)	Liquid pressure (MPa)	Spray dimensions (mm)				
				D1	D2	D3	D4	L
20	37	0.3	0.25-0.35	200	450	750	1,100	9,000
		0.4	0.35-0.45	250	500	850	1,200	10,000
		0.5	0.45-0.55	300	550	900	1,300	10,000
	55	0.3	0.25-0.35	250	500	800	1,200	10,000
		0.4	0.35-0.45	300	550	900	1,300	11,000
		0.5	0.45-0.55	350	600	1,000	1,400	11,000
	75	0.3	0.25-0.35	300	550	900	1,300	12,000
		0.4	0.35-0.45	350	650	1,000	1,400	13,000
		0.5	0.45-0.55	400	750	1,100	1,500	13,000
	110	0.3	0.25-0.35	350	600	1,000	1,400	12,000
		0.4	0.35-0.45	400	700	1,100	1,500	13,000
		0.5	0.45-0.55	450	800	1,200	1,600	13,000
	150	0.3	0.25-0.35	400	750	1,100	1,500	13,000
		0.4	0.35-0.45	450	800	1,200	1,600	14,000
		0.5	0.45-0.55	500	850	1,300	1,700	14,000
	220	0.3	0.25-0.35	450	800	1,200	1,500	13,000
		0.4	0.35-0.45	500	850	1,250	1,600	14,000
		0.5	0.45-0.55	550	900	1,300	1,700	14,000

Note: The above data were measured with tap water in a laboratory, in windless conditions.

**GSIMII series
Large Capacity Fine Fog Nozzles**

Gas cooling

GSIMII used in cooling tower

You can select spray angle 60° or 20° in accordance with furnace size and diameter.

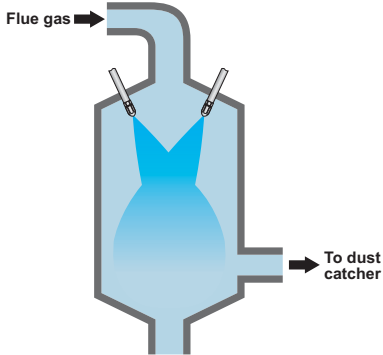

Dust suppression

Dust suppression around exit of rolling mill

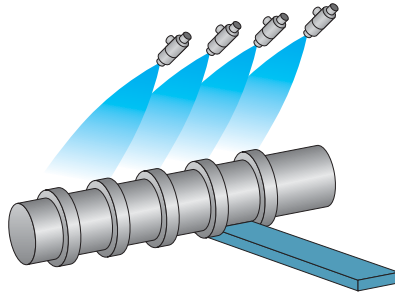

Cooling refractories

GSIMII spraying unit for cooling refractories



How to order

Please inquire or order for a specific nozzle using this coding system.

<Example> GSIM 6037II B S316L+ 1*1/4T10 SCS13 (L2)

GSIM	60	37	II	B	S316L+	1*1/4T10	SCS13	(L2)
	Spray angle code	Air consumption code		Type of Length (Total length)		Flange size		Length between the nozzle head and flange
	60 20	37 55 75 110 150 220		A B C D		1*1/4T10 1*1/2T10 2T10		

Applicable flange sizes
(Air consumption code: Flange size)
37II, 55II: 1*1/4T10
75II, 110II: 1*1/2T10
150II, 220II: 2T10

See the drawing and chart on page 29 for length type and L2.
For details please ask for our inquiry drawing.

Please inquire with us for flange sizes.

VVEA series

High Impact Flat Spray Semi-fine/Semi-coarse Fog Nozzles

Surface finish

- Precision cleaning for steel surface treatment
- Roll cleaning
- Cooling steel plate

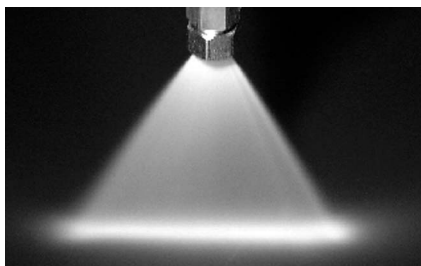

FEATURES

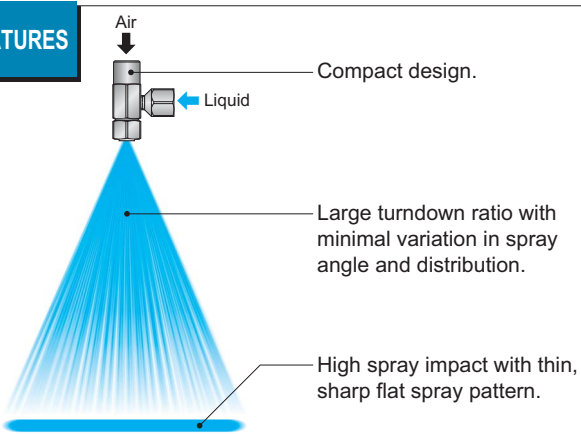

VVEA series

Spray angle 60°

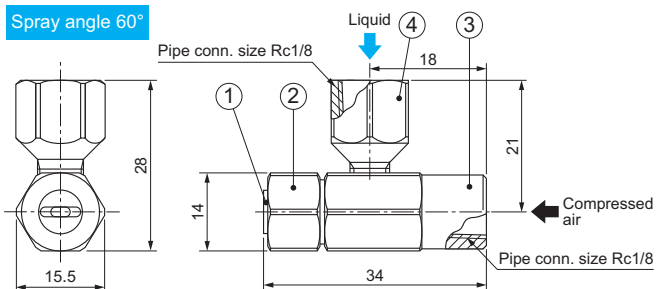

Spray angle 80°

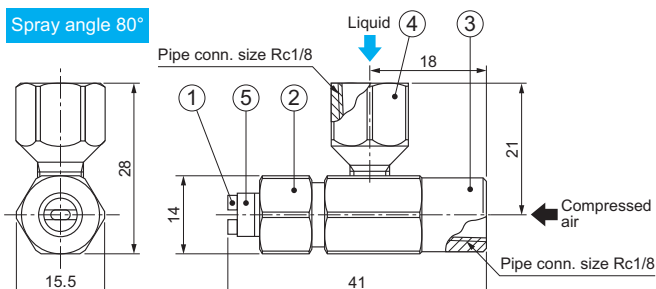

- ① Nozzle tip ② Cap ③ Mixing adaptor ④ Liquid socket ⑤ Sleeve

MATERIAL S303

MASS 50 g

Spray angle code	Spray capacity code	Air pressure (MPa)	Spray capacity (ℓ/min) & Air consumption (ℓ/min, Normal)			Mean droplet diameter* (μm)	Free passage diameter (mm)		
			Liquid pressure (MPa)				Spray orifice	Adaptor	
			0.2 Liquid / Air	0.3 Liquid / Air	0.5 Liquid / Air			Liquid	Air
80	05	0.2	0.31 / 17	0.45 / 14	—	20–250	0.8	0.7	0.9
		0.3	0.23 / 24	0.36 / 22	0.58 / 18				
		0.4	—	0.29 / 29	0.50 / 25				
		0.5	—	—	0.43 / 33				
	10	0.2	0.54 / 36	0.90 / 24	—	20–250	1.0	1.1	1.3
		0.3	0.30 / 58	0.60 / 49	1.28 / 25				
		0.4	—	0.39 / 74	1.00 / 50				
		0.5	—	—	0.81 / 69				
	20	0.2	0.96 / 44	1.98 / 18	—	30–300	1.1	1.6	1.6
		0.3	0.53 / 81	1.10 / 59	2.63 / 19				
		0.4	—	0.53 / 104	2.00 / 50				
		0.5	—	—	1.30 / 89				
30	0.2	1.34 / 50	—	—	40–400	1.3	1.9	1.9	
	0.3	0.63 / 100	1.60 / 64	—					
	0.4	—	0.88 / 128	3.00 / 50					
	0.5	—	—	2.25 / 85					
60	05	0.2	0.31 / 17	0.45 / 14	—	20–250	1.0	0.8	0.9
		0.3	0.23 / 24	0.36 / 22	0.58 / 18				
		0.4	—	0.29 / 29	0.50 / 25				
		0.5	—	—	0.43 / 33				
	10	0.2	0.54 / 36	0.90 / 24	—	20–250	1.4	1.1	1.3
		0.3	0.30 / 58	0.60 / 49	1.28 / 25				
		0.4	—	0.39 / 74	1.00 / 50				
		0.5	—	—	0.81 / 69				
	20	0.2	0.96 / 44	1.98 / 18	—	30–300	1.5	1.6	1.6
		0.3	0.53 / 81	1.10 / 59	2.63 / 19				
		0.4	—	0.53 / 104	2.00 / 50				
		0.5	—	—	1.30 / 89				
30	0.2	1.34 / 50	—	—	40–400	1.6	1.9	1.9	
	0.3	0.63 / 100	1.60 / 64	—					
	0.4	—	0.88 / 128	3.00 / 50					
	0.5	—	—	2.25 / 85					

*Sauter mean droplet diameters measured by laser Doppler method

Conversion of unit [Pressure] 0.1 MPa ≈ 14.50 psi [Flow rate] 1 ℓ (liter) ≈ 0.26 US gal.
10 psi ≈ 0.07 MPa 1 US gal. ≈ 3.79 ℓ (liter)

VVEA series
High Impact Flat Spray Semi-fine/Semi-coarse Fog Nozzles

VVEA Spray impact data

VVEA6010

Compressed air pressure: 0.4 MPa
Liquid pressure: 0.5 MPa

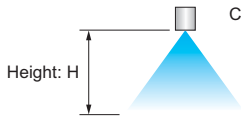

H = 50 mm

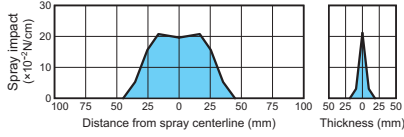

H = 75 mm

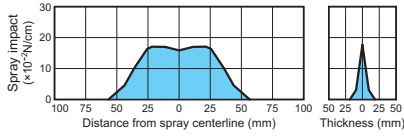

H = 100 mm

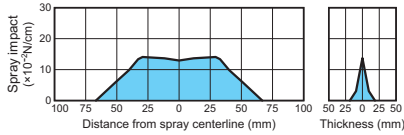

VVEA Integrated Spray Header

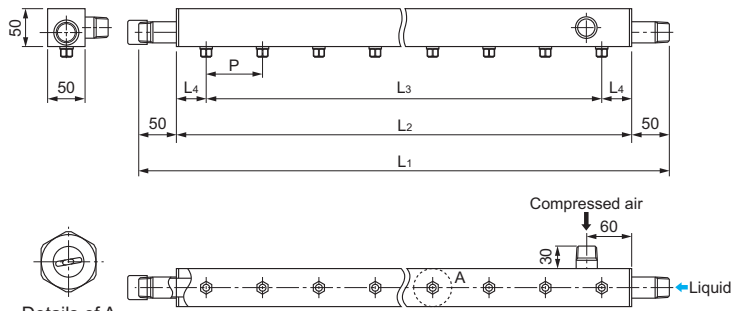

Details of A

- P: Nozzle spacing
- L1: Total length
- L2: Length of rectangular spray header
- L3: Distance between the nozzles of both ends
- L4: Distance to nozzle from the end of header

- Combines two pipes for air and liquid into one rectangular spray header. Compact and easy for installation and maintenance.
- Uniform spray distribution across the entire spray area.

How to order

Please inquire or order for a specific nozzle using this coding system.

<Example> 1/8 VVEA 8010 S303

1/8 VVEA	80	10	S303
	Spray angle code	Spray capacity code	
	80	05	
	60	10	
		20	
		30	

YYA series Wide-angle Flat Spray Pneumatic Spray Nozzles

Raw material process

- Dust suppression on raw material conveyor line



FEATURES

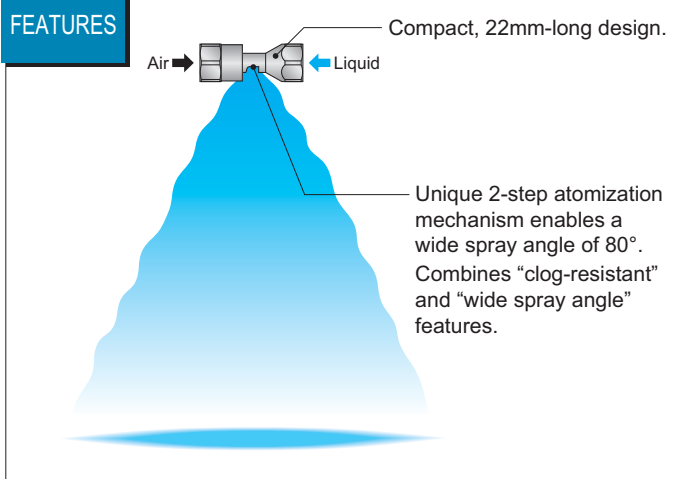

YYA series

MATERIAL S303

MASS 5 g

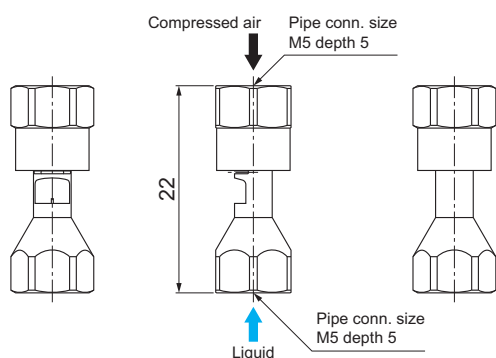
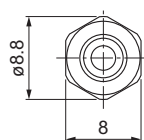

YYA Flow-rate diagram

How to read the chart

- The spray capacity shown is for one nozzle.
- Figures at the foot of each line indicate liquid pressures P_w in MPa.
- Figures in ovals ○ indicate Sauter mean droplet diameters (μm) measured by laser Doppler method.

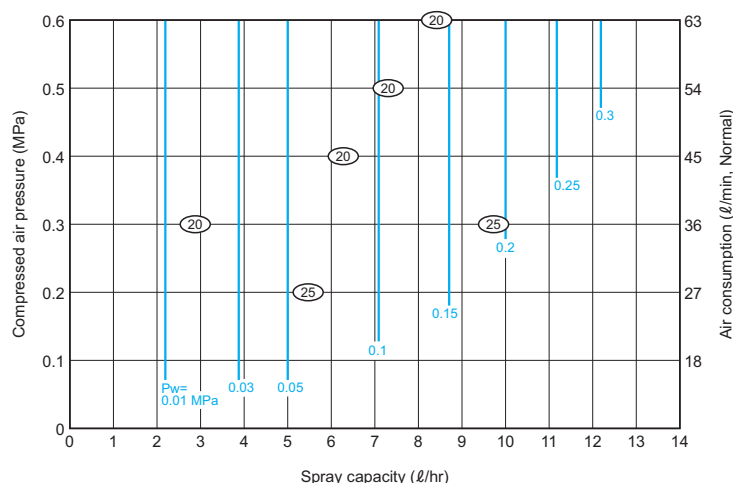

Spray angle code ¹⁾	Air consumption code	Air pressure (MPa)	Air consumption (ℓ/min, Normal)	Spray capacity (ℓ/hr)				Spray width (mm) ²⁾				Mean droplet diameter (μm)	Free passage diameter (mm)	
				Liquid pressure (MPa)				Liquid pressure (MPa)					Liquid	Air
				0.01	0.05	0.1	0.2	0.01	0.05	0.1	0.2			
80	04	0.2 0.3 0.4 0.5	27 36 45 54	2.2	5.0	7.1	10.0	160 170 170 180	170 170 180 180	170 180 190 200	— 190 200 210	15-30	0.4	0.2

*1) Spray angle measured at compressed air pressure of 0.3 MPa and liquid pressure of 0.05 MPa

*2) Spray width measured at 100 mm from nozzle

Note: Spray capacity and spray angle are reduced when viscous liquid is sprayed.

Conversion of unit [Pressure] 0.1 MPa ≈ 14.50 psi [Flow rate] 1 ℓ (liter) ≈ 0.26 US gal.
10 psi ≈ 0.07 MPa 1 US gal. ≈ 3.79 ℓ (liter)

How to order

Please inquire or order using this product code.

M5F YYA 8004 S303

BAVV series

Blower-air Driven Flat Spray Fine Fog Nozzles

Raw material process

- Dust suppression on raw material conveyor line

Rolling mill process

- Cooling steel plate

Surface finish

- Cooling steel plate in each process of CGL, CAPL, EGL, and CCL



FEATURES

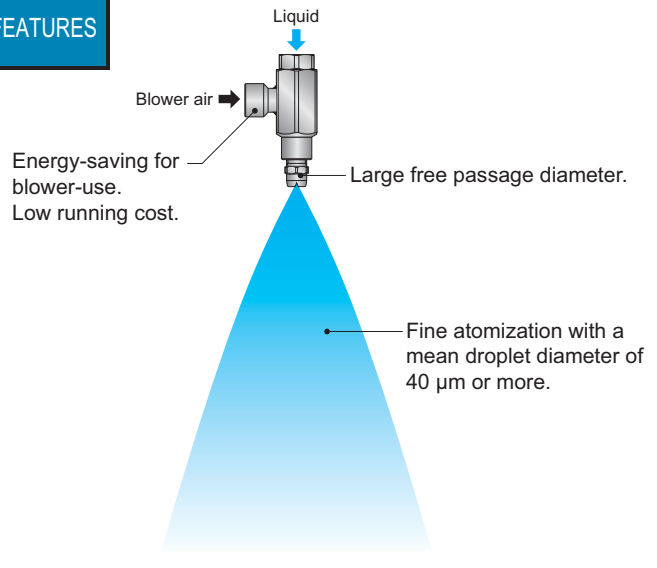

BAVV series

MATERIALS

- ① Nozzle: S303
- ② Mixing adaptor: S304
- ③ Air socket: S304
- ④ Liquid socket: S303

MASS

270 g
(280 g for BAVV6060S303)

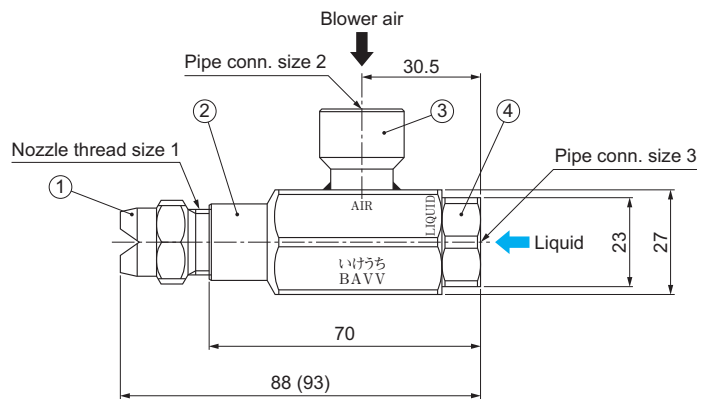
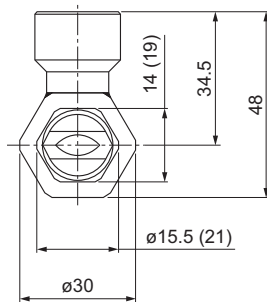

Dimensions in () show those of BAVV6060S303.

[Note] Appearance and dimensions may differ slightly depending on materials and nozzle codes.

Spray angle code*	Spray capacity code	Air pressure (MPa)	Spray capacity (ℓ/hr) / Air consumption (ℓ/min, Normal)			Free passage diameter (mm)			Nozzle thread size 1	Pipe conn. size 2	Pipe conn. size 3
			Liquid pressure (MPa)			Spray orifice	Adaptor				
			0.02	0.03	0.04		Liquid	Air		Air	Liquid
60	10	0.02	9.0 / 92	21.0 / 78	31.2 / 76	2.5	1.4	3.0	R1/4	Rc3/8	Rc1/4
	30		27.6 / 168	48.0 / 150	64.8 / 136	3.6	2.0		R1/4		
	60		57.6 / 254	94.2 / 220	123.0 / 190	4.7	2.6		R3/8		

*Spray angle measured at both air and liquid pressure of 0.02 MPa

Conversion of unit [Pressure] 0.1 MPa ≈ 14.50 psi [Flow rate] 1 ℓ (liter) ≈ 0.26 US gal.
10 psi ≈ 0.07 MPa 1 US gal. ≈ 3.79 ℓ (liter)

BAVV Flow-rate diagrams

How to read the chart

- The spray capacity shown is for one nozzle.
- Blue lines represent (blower) air pressures P_a in MPa, solid black lines represent liquid pressures P_w in MPa, and dotted lines represent air-water ratio Q_a/Q_w .
- Figures in ovals \bigcirc indicate Sauter mean droplet diameters (μm) measured by laser Doppler method.

BAVV6030

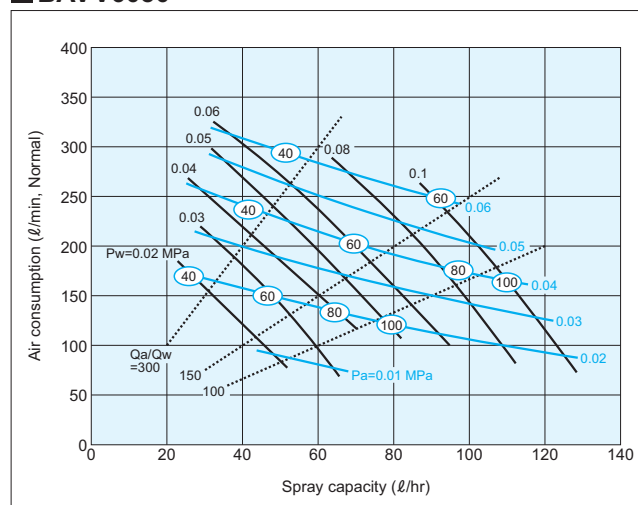

BAVV6010

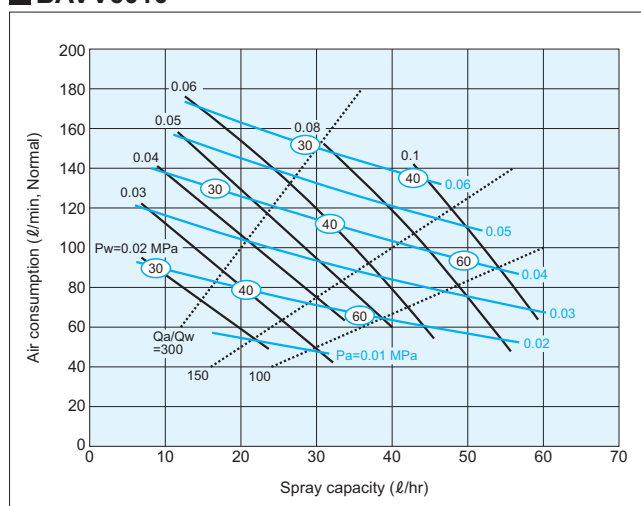

BAVV6060

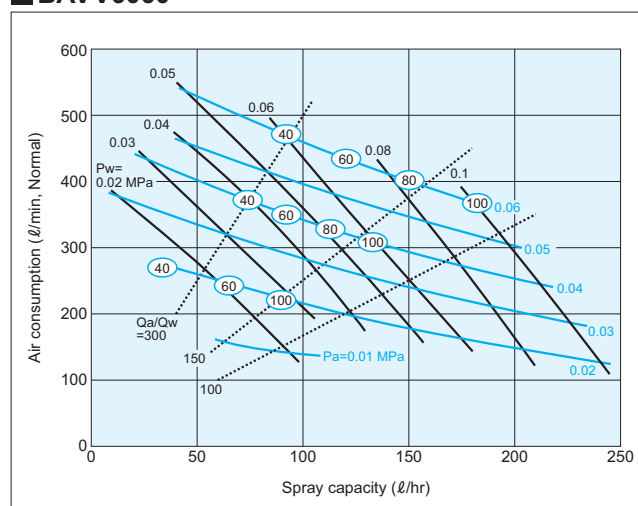

How to order

Please inquire or order for a specific nozzle using this coding system.

<Example> BAVV 6010 S303

BAVV 60 10 S303

Spray capacity
code

- 10
- 30
- 60

VVP series Standard Flat Spray Nozzles

Steel making process

- Cooling of electrodes of electric furnace
- Cooling bloom, billet

Rolling mill process

- Controlled cooling of steel plates
- Cooling of shaped steel
- Surface treatment of rolled sheets (Chemical spraying, rinsing)
- Cooling of plates and rolls in hot strip mills



FEATURES

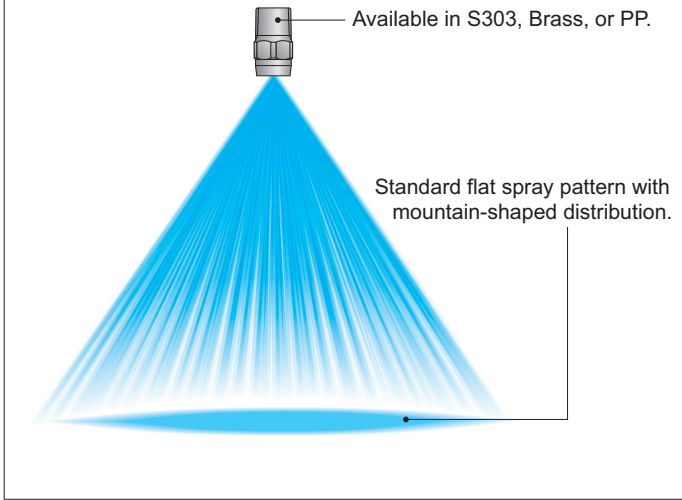

VVP series

MATERIALS

- S303 or B (brass), PP (injection-molded polypropylene)
- S316L equivalent (precision-molded stainless steel)^{*2}
- Strainer for precision-molded stainless steel: S303 or S316

OPTIONAL MATERIAL:

S316, PVC, PVDF, Ultrahigh molecular weight polyethylene, or others

Series	Pipe conn. size	Dimensions (mm)					Mass (g)			
		L ₁	L ₂	H	øD	N	S303	B	S316L equiv.	PP
VVP ^{*1}	R1/8	18.5	31	12	7.5	6.5	10	11	—	—
	R1/4	25	40	14	10	10.5	21	23	—	—
	R3/8	30	—	19	—	10.5	37	40	—	—
	R1/2	38	—	23	—	14	65	70	—	—
	R3/4	45	—	29	—	15	110	120	—	—
	R1	55	—	35	—	18	170	180	—	—
VVP ^{*2} (Precision-molded stainless steel)	R1/8	20	33.5	12	7.5	7	—	—	9.6	—
	R1/4	27	41	14	10	10.5	—	—	16	—
VVP (Injection molded)	R1/8	22	—	12	—	8.5	—	—	—	1.1
	R1/4	27	—	14	—	11.5	—	—	—	2.2

When with a strainer, add 2–5 g to the above mass.

*1) VVP nozzle with spray capacity code of 20 or smaller slightly differs in dimensions (L₁, L₂) and in shape of nozzle tip from the above. Please contact distributor for details.

*2) Please refer to the chart on page 42 for availability.

[Note] Appearance and dimensions may differ slightly depending on materials and nozzle codes.

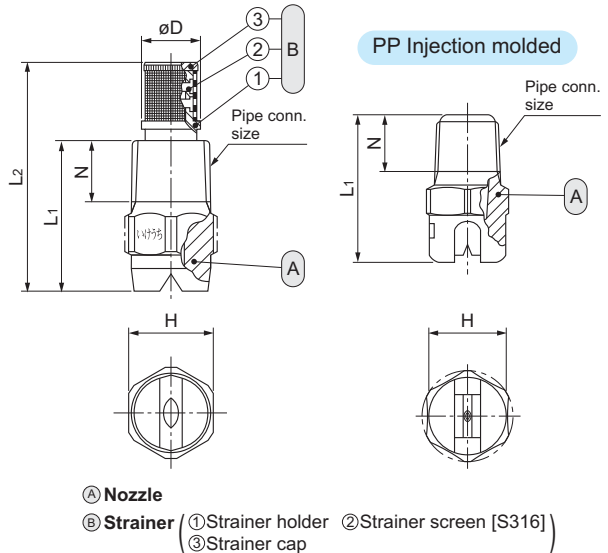

Precision-molded stainless steel

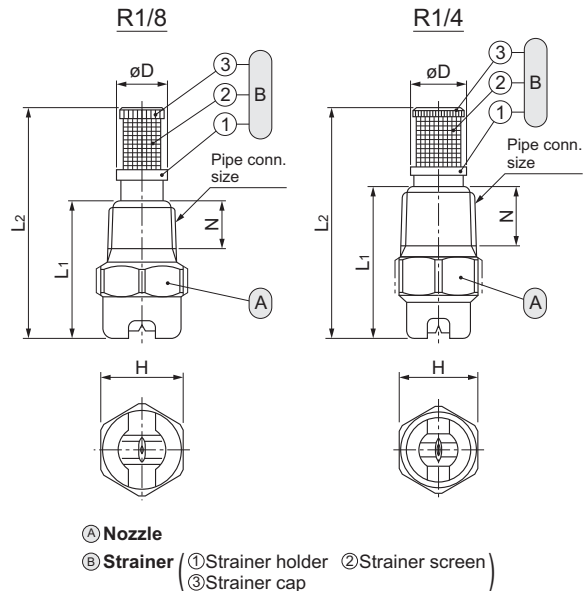

VVP series
Standard Flat Spray Nozzles

■ VVP series

Spray angle code	Spray capacity code	Pipe connection size								Spray angle (°)			Spray capacity (ℓ/min)								Mean drop. dia. (μm)	Free pass. dia. (mm)	Strainer mesh size	
		All metal					All plastic			0.15 MPa	0.3 MPa	0.7 MPa	0.05 MPa	0.1 MPa	0.15 MPa	0.2 MPa	0.3 MPa	0.5 MPa	0.7 MPa	1 MPa				2 MPa
		R1/8	R1/4	R3/8	R1/2	R3/4	R1	R1/8	R1/4															
115	03							○	○	101	115	124	—	0.17	0.21	0.24	0.30	0.39	0.46	0.55	0.77	140	0.2	200
	04							○	○	102	115	124	—	0.23	0.28	0.33	0.40	0.52	0.61	0.73	1.03	160	0.3	150
	05							○	○	102	115	124	—	0.29	0.35	0.41	0.50	0.65	0.76	0.91	1.29	160	0.3	150
	07							○	○	103	115	124	—	0.40	0.49	0.57	0.70	0.90	1.07	1.28	1.81	160	0.3	150
	10							○	○	103	115	124	0.41	0.58	0.71	0.82	1.00	1.29	1.53	1.83	2.58	160	0.4	150
	15		●					○	○	104	115	123	0.61	0.87	1.06	1.23	1.50	1.94	2.29	2.74	3.87	160	0.5	100
	20		●	●				○	○	104	115	123	0.82	1.15	1.41	1.63	2.00	2.58	3.06	3.65	5.16	270	0.6	100
	30		●	●				○	○	105	115	122	1.23	1.73	2.12	2.45	3.00	3.88	4.58	5.48	7.75	270	0.8	50
	40		●	●				○	○	106	115	122	1.63	2.31	2.83	3.27	4.00	5.16	6.11	7.30	10.3	270	0.8	50
	60		○	○						107	115	121	2.45	3.46	4.24	4.90	6.00	7.75	9.17	11.0	15.5	160	1.0	—
	80		○	○						107	115	121	3.27	4.62	5.66	6.53	8.00	10.3	12.2	14.6	20.6	160	1.2	—
	100		○	○						107	115	120	4.08	5.77	7.07	8.17	10.0	12.9	15.3	18.3	25.8	160	1.7	—
	200			○						109	115	120	8.16	11.5	14.1	16.3	20.0	25.8	30.6	36.5	51.6	510	2.4	—
	230			○	○					109	115	119	9.39	13.3	16.3	18.8	23.0	29.7	35.1	42.0	59.4	510	2.7	—
	260			○	○					109	115	119	10.6	15.0	18.4	21.2	26.0	33.6	39.7	47.5	67.1	510	2.8	—
300			○	○					109	115	119	12.2	17.3	21.2	24.5	30.0	38.7	45.8	54.8	77.5	510	3.0	—	
400				○	○				110	115	118	16.3	23.1	28.3	32.7	40.0	51.6	61.1	73.0	103	580	3.5	—	
500				○	○				110	115	118	20.4	28.9	35.4	40.8	50.0	64.6	76.4	91.3	129	580	3.9	—	
600				○	○				111	115	118	24.5	34.6	42.4	49.0	60.0	77.5	91.7	110	155	610	4.3	—	
800					○	○			111	115	117	32.7	46.2	56.5	65.3	80.0	103	122	146	206	700	5.0	—	
1000					○	○			111	115	117	40.8	57.7	70.7	81.7	100	129	153	183	258	700	5.6	—	
1500						○			111	115	117	61.2	86.6	106	122	150	194	229	274	387	900	7.2	—	
90	03							○	○	76	90	100	—	0.17	0.21	0.24	0.30	0.39	0.46	0.55	0.77	150	0.2	200
	04							○	○	77	90	100	—	0.23	0.28	0.33	0.40	0.52	0.61	0.73	1.03	170	0.3	150
	05							○	○	77	90	100	—	0.29	0.35	0.41	0.50	0.65	0.76	0.91	1.29	170	0.3	150
	07							○	○	78	90	100	—	0.40	0.49	0.57	0.70	0.90	1.07	1.28	1.81	170	0.4	150
	10							○	○	78	90	99	0.41	0.58	0.71	0.82	1.00	1.29	1.53	1.83	2.58	170	0.5	100
	15		●	●				○	○	79	90	99	0.61	0.87	1.06	1.23	1.50	1.94	2.29	2.74	3.87	170	0.6	100
	20		●	●				○	○	79	90	98	0.82	1.15	1.41	1.63	2.00	2.58	3.06	3.65	5.16	280	0.7	50
	30		●	●				○	○	80	90	97	1.23	1.73	2.12	2.45	3.00	3.88	4.58	5.48	7.75	280	0.9	50
	40		○	○				○	○	81	90	97	1.63	2.31	2.83	3.27	4.00	5.16	6.11	7.30	10.3	280	1.1	—
	50		○	○				○	○	81	90	97	2.04	2.89	3.54	4.08	5.00	6.46	7.64	9.13	12.9	280	1.2	—
	60		○	○						82	90	96	2.45	3.46	4.24	4.90	6.00	7.75	9.17	11.0	15.5	280	1.3	—
	80		○	○						82	90	96	3.27	4.62	5.66	6.53	8.00	10.3	12.2	14.6	20.6	280	1.5	—
	100		○	○						82	90	96	4.08	5.77	7.07	8.17	10.0	12.9	15.3	18.3	25.8	280	1.7	—
	120		○	○						83	90	95	4.90	6.93	8.49	9.80	12.0	15.5	18.3	21.9	31.0	280	2.0	—
	140			○						83	90	95	5.72	8.08	9.90	11.4	14.0	18.1	21.4	25.6	36.1	280	2.2	—
170			○	○					83	90	95	6.94	9.82	12.0	13.9	17.0	22.0	26.0	31.1	43.9	280	2.4	—	
200			○	○					84	90	95	8.16	11.5	14.1	16.3	20.0	25.8	30.6	36.5	51.6	540	2.6	—	
230			○	○					84	90	94	9.39	13.3	16.3	18.8	23.0	29.7	35.1	42.0	59.4	540	2.8	—	
260			○	○					84	90	94	10.6	15.0	18.4	21.2	26.0	33.6	39.7	47.5	67.1	540	3.1	—	
300			○	○					84	90	94	12.2	17.3	21.2	24.5	30.0	38.7	45.8	54.8	77.5	540	3.4	—	
400				○	○				85	90	94	16.3	23.1	28.3	32.7	40.0	51.6	61.1	73.0	103	580	3.8	—	
500				○	○				85	90	93	20.4	28.9	35.4	40.8	50.0	64.6	76.4	91.3	129	580	4.2	—	
600				○	○				86	90	93	24.5	34.6	42.4	49.0	60.0	77.5	91.7	110	155	610	4.7	—	
800					○	○			86	90	93	32.7	46.2	56.5	65.3	80.0	103	122	146	206	700	5.4	—	
900					○	○			86	90	92	36.7	52.0	63.6	73.5	90.0	116	137	164	232	750	5.7	—	
1000						○			86	90	92	40.8	57.7	70.7	81.7	100	129	153	183	258	750	6.0	—	
1200						○			86	90	92	49.0	69.3	84.9	98.0	120	155	183	219	310	850	6.6	—	
1500							○		86	90	92	61.2	86.6	106	122	150	194	229	274	387	950	7.2	—	
80	05	●	●					○	○	67	80	90	—	0.29	0.35	0.41	0.50	0.65	0.76	0.91	1.29	180	0.3	150
	07	●	●					○	○	68	80	89	—	0.40	0.49	0.57	0.70	0.90	1.07	1.28	1.81	180	0.4	150
	10	●	●					○	○	68	80	89	0.41	0.58	0.71	0.82	1.00	1.29	1.53	1.83	2.58	180	0.5	100
	15									69	80	88	0.61	0.87	1.06	1.23	1.50	1.94	2.29	2.74	3.87	180	0.7	50
	20		●							69	80	88	0.82	1.15	1.41	1.63	2.00	2.58	3.06	3.65	5.16	290	0.8	50
	30		○	○						70	80	87	1.23	1.73	2.12	2.45	3.00	3.88	4.58	5.48	7.75	290	1.0	—
	40		○	○						71	80	87	1.63	2.31	2.83	3.27	4.00	5.16	6.11	7.30	10.3	290	1.2	—
	50									71	80	86	2.04	2.89	3.54	4.08	5.00	6.46	7.64	9.13	12.9	290	1.4	—
	60									72	80	86	2.45	3.46	4.24	4.90	6.00	7.75	9.17	11.0	15.5	290	1.5	—
	80		○	○						72	80	86	3.27	4.62	5.66	6.53	8.00	10.3	12.2	14.6	20.6	290	1.7	—
	100		○	○						72	80	85	4.08	5.77	7.07	8.17	10.0	12.9	15.3	18.3	25.8	290	1.8	—
	120		○	○						73	80	85	4.90	6.93	8.49	9.80	12.0	15.5	18.3	21.9	31.0	290	2.1	—
	200			○						74	80	85	8.16	11.5	14.1	16.3	20.0	25.8	30.6	36.5	51.6	550	2.9	—
	300			○						74	80	84	12.2	17.3	21.2	24.5	30.0	38.7	45.8	54.8	77.5	570	3.7	—
	400				○	○				75	80	83	16.3	23.1	28.3	32.7	40.0	51.6	61.1	73.0	103	600	4.1	—
500				○	○				75	80	83	20.4	28.9	35.4	40.8	50.0	64.6	76.4	91.3	129	600	4.8	—	
600				○	○				76	80	83	24.5	34.6	42.4	49.0	60.0	77.5	91.7	110	155	610	5.1	—	
800					○	○			76	80	82	32.7	46.2	56.5	65.3	80.0	103	122	146	206	700	6.1	—	

VVP series
Standard Flat Spray Nozzles

Spray angle code	Spray capacity code	Pipe connection size								Spray angle (°)			Spray capacity (ℓ/min)						Mean drop. dia. (μm)	Free pass. dia. (mm)	Strainer mesh size							
		All metal					All plastic			0.15 MPa	0.3 MPa	0.7 MPa	0.05 MPa	0.1 MPa	0.15 MPa	0.2 MPa	0.3 MPa	0.5 MPa				0.7 MPa	1 MPa	2 MPa				
		R1/8	R1/4	R3/8	R1/2	R3/4	R1	R1/8	R1/4																			
65	03									52	65	75	—	0.17	0.21	0.24	0.30	0.39	0.46	0.55	0.77	160	0.3	150				
	04									52	65	75	—	0.23	0.28	0.33	0.40	0.52	0.61	0.73	1.03							
	05									52	65	74	—	0.29	0.35	0.41	0.50	0.65	0.76	0.91	1.29							
	07									53	65	74	—	0.40	0.49	0.57	0.70	0.90	1.07	1.28	1.81							
	10									54	65	73	0.41	0.58	0.71	0.82	1.00	1.29	1.53	1.83	2.58							
	15	●	●							54	65	73	0.61	0.87	1.06	1.23	1.50	1.94	2.29	2.74	3.87							
	20	●	●							55	65	72	0.82	1.15	1.41	1.63	2.00	2.58	3.06	3.65	5.16							
	30	○	○							56	65	72	1.23	1.73	2.12	2.45	3.00	3.88	4.58	5.48	7.75							
	40	○	○							56	65	71	1.63	2.31	2.83	3.27	4.00	5.16	6.11	7.30	10.3							
	50	○	○							57	65	71	2.04	2.89	3.54	4.08	5.00	6.46	7.64	9.13	12.9							
	60	○	○							57	65	71	2.45	3.46	4.24	4.90	6.00	7.75	9.17	11.0	15.5							
	80	○	○					○	○	58	65	71	3.27	4.62	5.66	6.53	8.00	10.3	12.2	14.6	20.6							
	100	○	○							58	65	70	4.08	5.77	7.07	8.17	10.0	12.9	15.3	18.3	25.8							
	120	○	○							58	65	70	4.90	6.93	8.49	9.80	12.0	15.5	18.3	21.9	31.0							
	140	○	○							59	65	69	5.72	8.08	9.90	11.4	14.0	18.1	21.4	25.6	36.1							
	170	○	○							59	65	69	6.94	9.82	12.0	13.9	17.0	22.0	26.0	31.1	43.9							
	200	○	○							59	65	69	8.16	11.5	14.1	16.3	20.0	25.8	30.6	36.5	51.6							
	300	○	○							60	65	69	12.2	17.3	21.2	24.5	30.0	38.7	45.8	54.8	77.5							
	400	○	○							60	65	68	16.3	23.1	28.3	32.7	40.0	51.6	61.1	73.0	103							
	500	○	○							61	65	67	20.4	28.9	35.4	40.8	50.0	64.6	76.4	91.3	129							
600	○	○	○	○					61	65	67	24.5	34.6	42.4	49.0	60.0	77.5	91.7	110	155								
800	○	○	○	○					62	65	67	32.7	46.2	56.5	65.3	80.0	103	122	146	206								
1000	○	○	○	○					62	65	66	40.8	57.7	70.7	81.7	100	129	153	183	258								
1500	○	○	○	○					62	65	66	61.2	86.6	106	122	150	194	229	274	387								
50	05	●	●							38	50	59	—	0.29	0.35	0.41	0.50	0.65	0.76	0.91	1.29	210	0.4	150				
	07	●	●							38	50	58	—	0.40	0.49	0.57	0.70	0.90	1.07	1.28	1.81							
	10	●	●							40	50	58	0.41	0.58	0.71	0.82	1.00	1.29	1.53	1.83	2.58							
	15	○	○							40	50	57	0.61	0.87	1.06	1.23	1.50	1.94	2.29	2.74	3.87							
	20	○	○							41	50	57	0.82	1.15	1.41	1.63	2.00	2.58	3.06	3.65	5.16							
	30	○	○							42	50	56	1.23	1.73	2.12	2.45	3.00	3.88	4.58	5.48	7.75							
	40	○	○					○	○	42	50	56	1.63	2.31	2.83	3.27	4.00	5.16	6.11	7.30	10.3							
	50	○	○							43	50	55	2.04	2.89	3.54	4.08	5.00	6.46	7.64	9.13	12.9							
	60	○	○							43	50	55	2.45	3.46	4.24	4.90	6.00	7.75	9.17	11.0	15.5							
	80	○	○							43	50	55	3.27	4.62	5.66	6.53	8.00	10.3	12.2	14.6	20.6							
	120	○	○							44	50	54	4.90	6.93	8.49	9.80	12.0	15.5	18.3	21.9	31.0							
	200	○	○							45	50	53	8.16	11.5	14.1	16.3	20.0	25.8	30.6	36.5	51.6							
	300	○	○							45	50	53	12.2	17.3	21.2	24.5	30.0	38.7	45.8	54.8	77.5							
	400	○	○	○	○					46	50	52	16.3	23.1	28.3	32.7	40.0	51.6	61.1	73.0	103							
	500	○	○	○	○					46	50	52	20.4	28.9	35.4	40.8	50.0	64.6	76.4	91.3	129							
	600	○	○	○	○					47	50	52	24.5	34.6	42.4	49.0	60.0	77.5	91.7	110	155							
	800	○	○	○	○					47	50	51	32.7	46.2	56.5	65.3	80.0	103	122	146	206							
	1000	○	○	○	○					47	50	51	40.8	57.7	70.7	81.7	100	129	153	183	258							
	1500	○	○	○	○					48	50	51	61.2	86.6	106	122	150	194	229	274	387							
	40	05	●	●							30	40	48	—	0.29	0.35	0.41	0.50	0.65	0.76	0.91				1.29	230	0.4	150
07		●	●							30	40	48	—	0.40	0.49	0.57	0.70	0.90	1.07	1.28	1.81							
10		●	●							31	40	47	0.41	0.58	0.71	0.82	1.00	1.29	1.53	1.83	2.58							
20		○	○							32	40	46	0.82	1.15	1.41	1.63	2.00	2.58	3.06	3.65	5.16							
30		○	○							33	40	46	1.23	1.73	2.12	2.45	3.00	3.88	4.58	5.48	7.75							
40		○	○							33	40	45	1.63	2.31	2.83	3.27	4.00	5.16	6.11	7.30	10.3							
80		○	○							34	40	44	3.27	4.62	5.66	6.53	8.00	10.3	12.2	14.6	20.6							
120		○	○							35	40	44	4.90	6.93	8.49	9.80	12.0	15.5	18.3	21.9	31.0							
200		○	○							35	40	43	8.16	11.5	14.1	16.3	20.0	25.8	30.6	36.5	51.6							
300		○	○							36	40	42	12.2	17.3	21.2	24.5	30.0	38.7	45.8	54.8	77.5							
400		○	○							36	40	42	16.3	23.1	28.3	32.7	40.0	51.6	61.1	73.0	103							
500		○	○	○	○					37	40	42	20.4	28.9	35.4	40.8	50.0	64.6	76.4	91.3	129							
600		○	○	○	○					37	40	42	24.5	34.6	42.4	49.0	60.0	77.5	91.7	110	155							
800		○	○	○	○					37	40	41	32.7	46.2	56.5	65.3	80.0	103	122	146	206							
1000		○	○	○	○					38	40	41	40.8	57.7	70.7	81.7	100	129	153	183	258							
1500		○	○	○	○					38	40	41	61.2	86.6	106	122	150	194	229	274	387							
25		05	●	●							18	25	32	—	0.29	0.35	0.41	0.50	0.65	0.76	0.91	1.29	270	0.5	100			
		07	●	●							18	25	32	—	0.40	0.49	0.57	0.70	0.90	1.07	1.28	1.81						
		15	○	○							19	25	31	0.61	0.87	1.06	1.23	1.50	1.94	2.29	2.74	3.87						
		30	○	○							19	25	30	1.23	1.73	2.12	2.45	3.00	3.88	4.58	5.48	7.75						
	40	○	○							19	25	30	1.63	2.31	2.83	3.27	4.00	5.16	6.11	7.30	10.3							
	80	○	○							20	25	29	3.27	4.62	5.66	6.53	8.00	10.3	12.2	14.6	20.6							
	200	○	○							21	25	27	8.16	11.5	14.1	16.3	20.0	25.8	30.6	36.5	51.6							
	300	○	○							21	25	27	12.2	17.3	21.2	24.5	30.0	38.7	45.8	54.8	77.5							
	15	05	●	●							9	15	22	—	0.29	0.35	0.41	0.50	0.65	0.76	0.91	1.29				310	0.5	100
		07	●	●							9	15	21	—	0.40	0.49	0.57	0.70	0.90	1.07	1.28	1.81						
15		○	○							10	15	20	0.61	0.87	1.06	1.23	1.50	1.94	2.29	2.74	3.87							
30		○	○							10	15	19	1.23	1.73	2.12	2.45	3.00	3.88	4.58	5.48	7.75							
40		○	○							10	15	19	1.63	2.31	2.83	3.27	4.00	5.16	6.11	7.30	10.3							
80		○	○							11	15	18	3.27	4.62	5.66	6.53	8.00	10.3	12.2	14.6	20.6							
200		○	○							11	15	17	8.16	11.5	14.1	16.3	20.0	25.8	30.6	36.5	51.6							
300		○	○							12	15	17	12.2	17.3	21.2	24.5	30.0	38.7	45.8	54.8								

VVP series
Standard Flat Spray Nozzles

■ VVP series (Precision-molded stainless steel, small spray capacity)

Spray angle code	Spray capacity code	Pipe conn. size		Spray angle (°)			Spray capacity (ℓ/min)									Mean drop. dia. (μm)	Free pass. dia. (mm)	Strainer mesh size
		R1/8	R1/4	0.15 MPa	0.3 MPa	0.7 MPa	0.05 MPa	0.1 MPa	0.15 MPa	0.2 MPa	0.3 MPa	0.5 MPa	0.7 MPa	1 MPa	2 MPa			
115	03	●	●	101	115	124	—	—	0.21	0.24	0.30	0.39	0.46	0.55	0.77	140	0.2	200
	04	●	●	102	115	124	—	—	0.28	0.33	0.40	0.52	0.61	0.73	1.03		0.2	200
	05	●	●	102	115	124	—	0.29	0.35	0.41	0.50	0.65	0.76	0.91	1.29		0.3	150
	07	●	●	103	115	124	—	0.40	0.49	0.57	0.70	0.90	1.07	1.28	1.81		0.3	150
	10	●	●	103	115	124	0.41	0.58	0.71	0.82	1.00	1.29	1.53	1.83	2.58	270	0.4	150
90	03	●	●	76	90	100	—	—	0.21	0.24	0.30	0.39	0.46	0.55	0.77	150	0.2	200
	04	●	●	77	90	100	—	—	0.28	0.33	0.40	0.52	0.61	0.73	1.03		0.3	150
	05	●	●	77	90	100	—	0.29	0.35	0.41	0.50	0.65	0.76	0.91	1.29		0.3	150
	07	●	●	78	90	100	—	0.40	0.49	0.57	0.70	0.90	1.07	1.28	1.81		0.4	150
	10	●	●	78	90	99	0.41	0.58	0.71	0.82	1.00	1.29	1.53	1.83	2.58	280	0.5	100
80	07	●	●	68	80	89	—	0.40	0.49	0.57	0.70	0.90	1.07	1.28	1.81	180	0.4	150
	10	●	●	68	80	89	0.41	0.58	0.71	0.82	1.00	1.29	1.53	1.83	2.58	290	0.5	100
65	03	●	●	52	65	75	—	—	0.21	0.24	0.30	0.39	0.46	0.55	0.77	160	0.3	150
	04	●	●	52	65	75	—	—	0.28	0.33	0.40	0.52	0.61	0.73	1.03		0.3	150
	05	●	●	52	65	74	—	0.29	0.35	0.41	0.50	0.65	0.76	0.91	1.29		0.4	150
	07	●	●	53	65	74	—	0.40	0.49	0.57	0.70	0.90	1.07	1.28	1.81		0.5	100
	10	●	●	54	65	73	0.41	0.58	0.71	0.82	1.00	1.29	1.53	1.83	2.58	310	0.6	100

●: With strainer (Also available without strainer)

Conversion of unit [Pressure] 0.1 MPa ≈ 14.50 psi [Flow rate] 1 ℓ (liter) ≈ 0.26 US gal.
10 psi ≈ 0.07 MPa 1 US gal. ≈ 3.79 ℓ (liter)

How to order

Please inquire or order for a specific nozzle using this coding system.

① VVP series

<Example> 1/4M VVP 11515 S303W

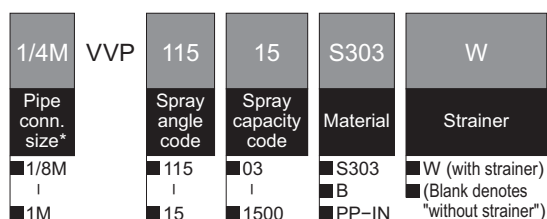

② VVP series (Precision-molded stainless steel, small spray capacity)

<Example> 1/4M VVP 6507S316L-IN + WS303

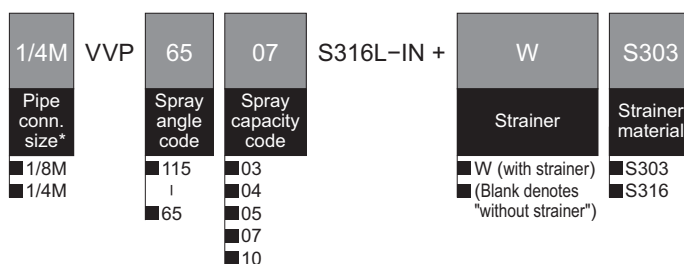

**M" indicates male thread ("R" of the ISO standard) and "F" indicates female thread ("Rc" of the ISO standard).

To order, please specify the pipe connection size by replacing respectively "R" and "Rc" by "M" and "F" as in the above chart.

Uniform spray distribution with multiple VVP nozzle alignment

The standard flat spray nozzle is designed to produce a mountain-shaped distribution in order to obtain uniform spray distribution in multiple nozzle alignment. If some nozzles do not spray as specified, the desired spray distribution in nozzle alignment can not be obtained. This is why IKEUCHI guarantees our precision nozzle performance.

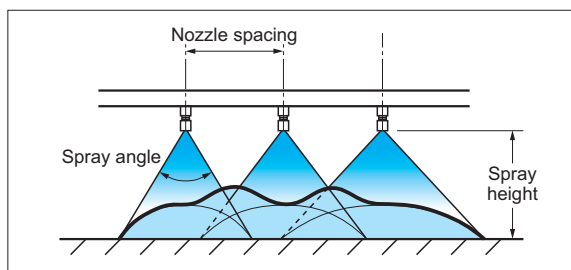

By positioning nozzles with an offset angle of 15° and overlapping at both ends, interference from adjacent sprays is prevented and uniform spray distribution can be maintained.

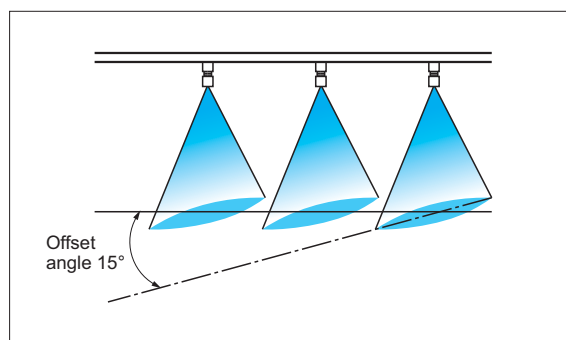

WVVP series Thick Flat Spray Nozzles

Rolling mill process

- Roll cooling
- Cooling steel plates

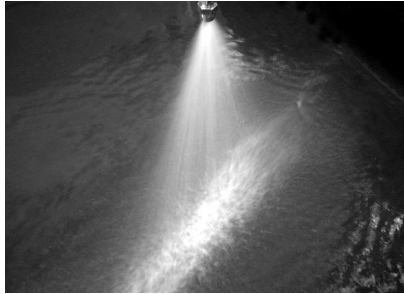
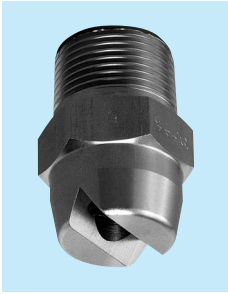

FEATURES

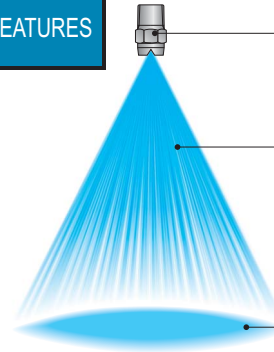

Simple structure, clog-resistant design having large free passage diameter.

High spray impact and large spray area. Tapered spray pattern edges provide uniform cooling effect in multiple-nozzle alignment.

Features thick flat spray pattern with thickness-width ratio of 1:2–4.

WVVP nozzles used in cooling application

● Roll cooling

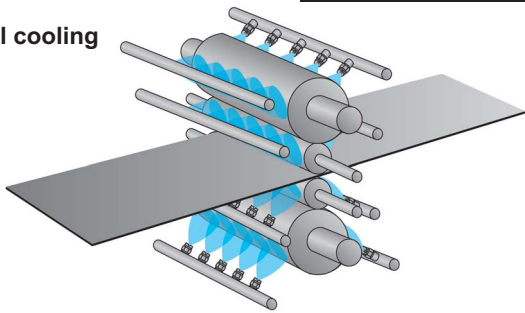

WVVP achieves uniform and effective cooling.

● Cooling steel plates

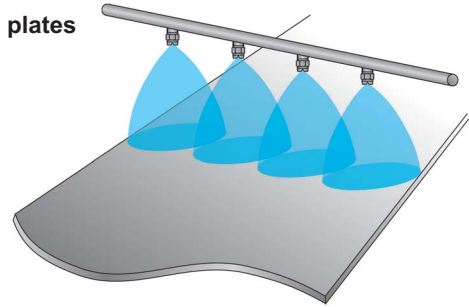

WVVP provides a wide and uniform cooling zone.

WVVP series

MATERIAL S303

Pipe conn. size	Dimensions (mm)			Mass (g)
	L	H	N	
R1/2	38	23	14	65
R3/4	45	29	15	110
R1	55	35	18	170

[Note] Appearance and dimensions may differ slightly depending on materials and nozzle codes.

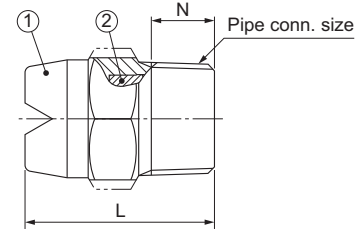
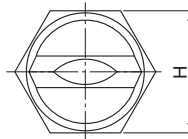

① Nozzle body ② Deflector

Spray angle and spray capacity codes	Pipe connection size			Spray angle (°)		Spray capacity (ℓ/min)					Free passage diameter (mm)
				Width	Thickness						
	R1/2	R3/4	R1	0.3 MPa		0.05 MPa	0.1 MPa	0.2 MPa	0.3 MPa	0.5 MPa	
3*80/28	○			80	20	11.5	16	22.8	28.0	36.1	3.5
3*80/35	○			80	20	14.2	20.1	28.6	35.0	45.2	3.9
3*50/40	○			50	20	16.3	23.1	32.7	40.0	51.6	4.9
5*80/100		○		75	20	31.6	44.7	63.2	77.5	100	6.4
3*80/200			○	80	20	81.6	115	163	200	258	10.4
3*50/200			○	50	20	81.6	115	163	200	258	11.0

Conversion of unit [Pressure] 0.1 MPa ≈ 14.50 psi [Flow rate] 1 ℓ (liter) ≈ 0.26 US gal.
10 psi ≈ 0.07 MPa 1 US gal. ≈ 3.79 ℓ (liter)

How to order

Please inquire or order for a specific nozzle using this coding system.

<Example> 1/2M WVVP 3*50/40 S303

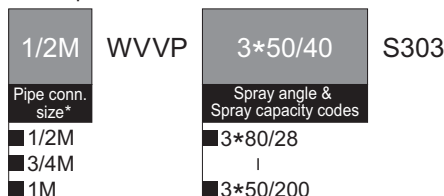

*"M" indicates male thread ("R" of the ISO standard) and "F" indicates female thread ("Rc" of the ISO standard).

To order, please specify the pipe connection size by replacing respectively "R" and "Rc" by "M" and "F" as in the above chart.

VVEP series Even Flat Spray Nozzles

Rolling mill process

- Roll cooling
- Cooling steel plates



FEATURES

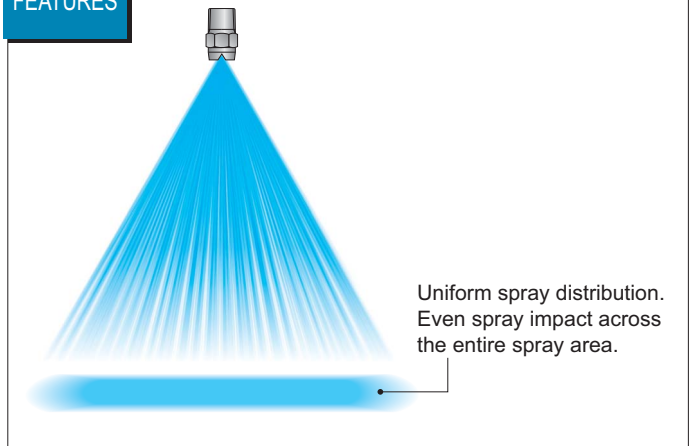

VVEP series

MATERIAL S303

Pipe conn. size	Dimensions (mm)			Mass (g)
	L	H	N	
R1/4	25	14	9.5	21
R3/8	30	19	10.5	37
R1/2	38	23	14	65

[Note] Appearance and dimensions may differ slightly depending on materials and nozzle codes.

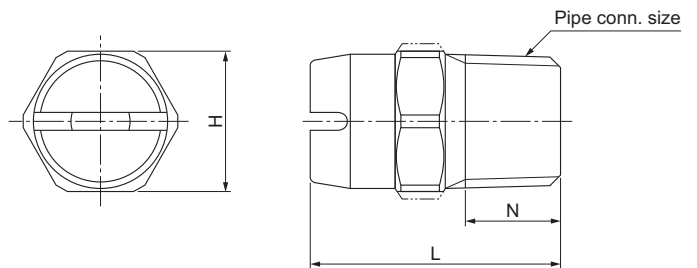

Spray angle code	Spray capacity code	Pipe connection size			Spray angle (°)			Spray capacity (ℓ/min)								Mean drop. dia. (μm)	Free pass. dia. (mm)	
		R1/4	R3/8	R1/2	0.15 MPa	0.3 MPa	0.7 MPa	0.05 MPa	0.1 MPa	0.15 MPa	0.2 MPa	0.3 MPa	0.5 MPa	0.7 MPa	1 MPa			2 MPa
90	40	○			81	90	97	1.63	2.31	2.83	3.27	4.00	5.16	6.11	7.30	10.3	320	0.9
	60	○			82	90	96	2.45	3.46	4.24	4.90	6.00	7.75	9.17	11.0	15.5	350	1.2
	80	○			82	90	96	3.27	4.62	5.66	6.53	8.00	10.3	12.2	14.6	20.6	380	1.4
	100	○			82	90	96	4.08	5.77	7.07	8.17	10.0	12.9	15.3	18.3	25.8	410	1.5
	200		○		84	90	95	8.16	11.5	14.1	16.3	20.0	25.8	30.6	36.5	51.6	490	2.2
400			○	85	90	94	16.3	23.1	28.3	32.7	40.0	51.6	61.1	73.0	103	590	3.1	
80	40	○			71	80	87	1.63	2.31	2.83	3.27	4.00	5.16	6.11	7.30	10.3	330	1.0
	60	○			72	80	86	2.45	3.46	4.24	4.90	6.00	7.75	9.17	11.0	15.5	360	1.3
	80	○			72	80	86	3.27	4.62	5.66	6.53	8.00	10.3	12.2	14.6	20.6	390	1.6
	100	○			72	80	85	4.08	5.77	7.07	8.17	10.0	12.9	15.3	18.3	25.8	420	1.7
	200		○		74	80	85	8.16	11.5	14.1	16.3	20.0	25.8	30.6	36.5	51.6	500	2.6
400			○	75	80	83	16.3	23.1	28.3	32.7	40.0	51.6	61.1	73.0	103	600	3.7	
65	40	○			56	65	71	1.63	2.31	2.83	3.27	4.00	5.16	6.11	7.30	10.3	350	1.3
	60	○			57	65	71	2.45	3.46	4.24	4.90	6.00	7.75	9.17	11.0	15.5	390	1.4
	80	○			58	65	71	3.27	4.62	5.66	6.53	8.00	10.3	12.2	14.6	20.6	420	1.8
	100	○			58	65	70	4.08	5.77	7.07	8.17	10.0	12.9	15.3	18.3	25.8	440	2.0
	200		○		59	65	69	8.16	11.5	14.1	16.3	20.0	25.8	30.6	36.5	51.6	530	2.9
400			○	60	65	68	16.3	23.1	28.3	32.7	40.0	51.6	61.1	73.0	103	640	4.4	

Conversion of unit [Pressure] 0.1 MPa ≈ 14.50 psi [Flow rate] 1 ℓ (liter) ≈ 0.26 US gal.
10 psi ≈ 0.07 MPa 1 US gal. ≈ 3.79 ℓ (liter)

How to order

Please inquire or order for a specific nozzle using this coding system.

<Example> 1/4M VVEP 9040 S303

1/4M	VVEP	90	40	S303
Pipe conn. size*		Spray angle code	Spray capacity code	
■ 1/4M		■ 90	■ 40	
■ 3/8M		■ 80	■ I	
■ 1/2M		■ 65	■ 400	

**M" indicates male thread ("R" of the ISO standard) and "F" indicates female thread ("Rc" of the ISO standard).

To order, please specify the pipe connection size by replacing respectively "R" and "Rc" by "M" and "F" as in the above chart.

WVVEP series

Thick Flat Spray Nozzles with Even Distribution

Plate/Hot strip mill

- Roll cooling
- Cooling plates and steel sheets
- Cooling casted steel

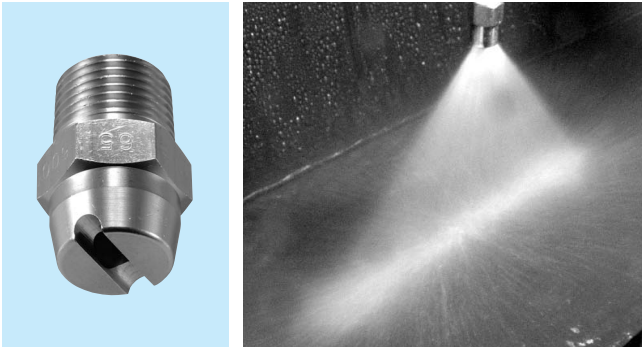

FEATURES

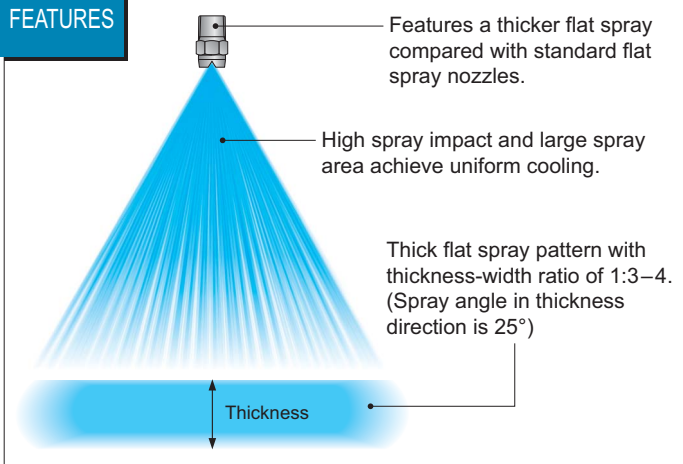

WVVEP series

MATERIALS S303 or B (Brass)

Pipe conn. size	Dimensions (mm)			Mass (g)	
	L	H	N	S303	B
R1/4	25	14	9.5	21	23
R3/8	30	19	10.5	37	40
R1/2	38	23	14	65	70

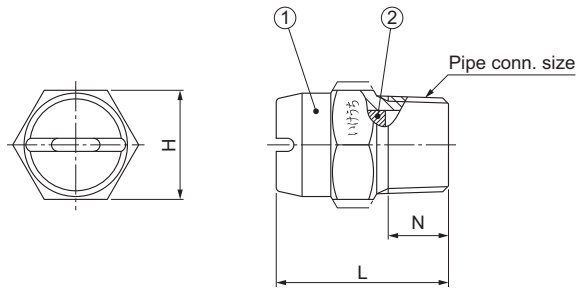

[Note] Appearance and dimensions may differ slightly depending on materials and nozzle codes.

① Nozzle body ② Deflector

Spray angle code	Spray capacity code	Pipe connection size			Spray angle (°)		Spray capacity (ℓ/min)								Mean droplet diameter (μm)	Free passage diameter (mm)
		R1/4	R3/8	R1/2	Width	Thickness	0.05 MPa	0.1 MPa	0.2 MPa	0.3 MPa	0.5 MPa	0.7 MPa	1 MPa	2 MPa		
										0.3 MPa						
90	120	○			90	25	4.90	6.93	9.80	12.0	15.5	18.3	21.9	31.0	400	1.6
	140	○			90	25	5.72	8.08	11.4	14.0	18.1	21.4	25.6	36.1	415	1.6
	200		○		90	25	8.16	11.5	16.3	20.0	25.8	30.6	36.5	51.6	460	1.8
	260		○		90	25	10.6	15.0	21.2	26.0	33.6	39.7	47.5	67.1	510	1.9
	300		○		90	25	12.2	17.3	24.5	30.0	38.7	45.8	54.8	77.5	510	2.0
	400			○	90	25	16.3	23.1	32.7	40.0	51.6	61.1	73.0	103	550	2.1
	500			○	90	25	20.4	28.9	40.8	50.0	64.6	76.4	91.3	129	620	2.2
600			○	90	25	24.5	34.6	49.0	60.0	77.5	91.7	110	155	620	2.4	
65	120	○			65	25	4.90	6.93	9.80	12.0	15.5	18.3	21.9	31.0	430	2.8
	140	○			65	25	5.72	8.08	11.4	14.0	18.1	21.4	25.6	36.1	450	2.9
	200		○		65	25	8.16	11.5	16.3	20.0	25.8	30.6	36.5	51.6	500	3.2
	260		○		65	25	10.6	15.0	21.2	26.0	33.6	39.7	47.5	67.1	510	3.4
	300		○		65	25	12.2	17.3	24.5	30.0	38.7	45.8	54.8	77.5	560	3.5
	400			○	65	25	16.3	23.1	32.7	40.0	51.6	61.1	73.0	103	600	3.7
	500			○	65	25	20.4	28.9	40.8	50.0	64.6	76.4	91.3	129	670	4.0
600			○	65	25	24.5	34.6	49.0	60.0	77.5	91.7	110	155	670	4.5	

Conversion of unit [Pressure] 0.1 MPa ≈ 14.50 psi [Flow rate] 1 ℓ (liter) ≈ 0.26 US gal.
10 psi ≈ 0.07 MPa 1 US gal. ≈ 3.79 ℓ (liter)

How to order

Please inquire or order for a specific nozzle using this coding system.

<Example> 1/4M WVVEP 90120 S303

1/4M	WVVEP	90	120	S303
Pipe conn. size*		Spray angle code	Spray capacity code	Material
■ 1/4M		■ 90	■ 120	■ S303
■ 3/8M		■ 65	■ I	■ B
■ 1/2M			■ 600	

*"M" indicates male thread ("R" of the ISO standard) and "F" indicates female thread ("Rc" of the ISO standard).

To order, please specify the pipe connection size by replacing respectively "R" and "Rc" by "M" and "F" as in the above chart.

EJVV
series

Air Mixing Type Flat Spray Nozzles

Iron making process

- Washing electric precipitator pole plates

Rolling mill process

- Cooling steel plates

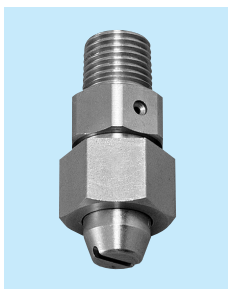

FEATURES

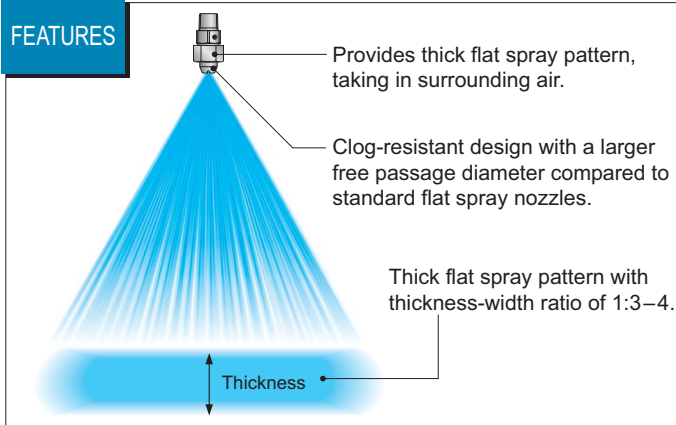

EJVV used in cooling steel plates

EJVV series nozzles, with large spray coverage in thickness direction, achieve uniform and effective cooling in the entire spray area.

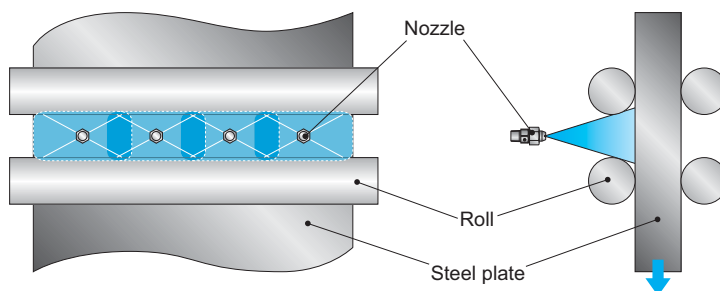

MATERIALS S303 or B (Brass)

OPTIONAL MATERIAL: S316 or others

MASS

S303: 57 g, B: 60 g

[Note] Appearance and dimensions may differ slightly depending on materials and nozzle codes.

EJVV series

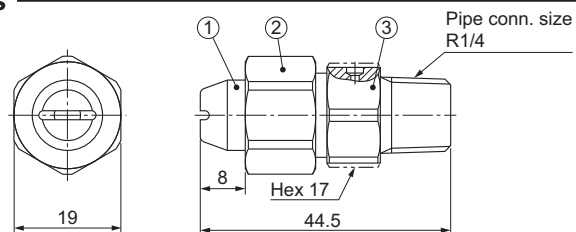

Spray angle code	Spray capacity code	Spray angle (°)		Spray capacity (ℓ/min)						Mean droplet diameter (μm)	Free passage diameter (mm)
		0.3 MPa	0.7 MPa	0.25 MPa	0.3 MPa	0.5 MPa	0.7 MPa	1 MPa	2 MPa		
90	20	90	90	1.83	2.00	2.58	3.06	3.65	5.16	320	0.9
	30	90	90	2.74	3.00	3.87	4.58	5.48	7.75		
	40	90	90	3.65	4.00	5.16	6.11	7.30	10.3		
	50	90	90	4.56	5.00	6.45	7.64	9.13	12.9	420	1.5
	60	90	90	5.78	6.00	7.75	9.17	11.0	15.5		
	80	90	90	7.30	8.00	10.3	12.2	14.6	20.7		
	100	90	90	9.13	10.0	12.9	15.3	18.3	25.8		
120	90	90	11.0	12.0	15.5	18.3	21.9	31.0	570	2.2	
80	20	80	80	1.83	2.00	2.58	3.06	3.65	5.16	320	0.9
	30	80	80	2.74	3.00	3.87	4.58	5.48	7.75		
	40	80	80	3.65	4.00	5.16	6.11	7.30	10.3		
	50	80	80	4.56	5.00	6.45	7.64	9.13	12.9	430	1.5
	60	80	80	5.78	6.00	7.75	9.17	11.0	15.5		
	80	80	80	7.30	8.00	10.3	12.2	14.6	20.7		
	100	80	80	9.13	10.0	12.9	15.3	18.3	25.8		
120	80	80	11.0	12.0	15.5	18.3	21.9	31.0	590	2.6	

Cautions for use

Spray pressure must be 0.25 MPa or higher to provide stable spray pattern.
Low pressure causes unstable spraying since EJVV series nozzle takes in surrounding air.

Conversion of unit [Pressure] 0.1 MPa ≈ 14.50 psi [Flow rate] 1 ℓ (liter) ≈ 0.26 US gal.
10 psi ≈ 0.07 MPa 1 US gal. ≈ 3.79 ℓ (liter)

How to order

Please inquire or order for a specific nozzle using this coding system.

<Example> 1/4M EJVV 9020 S303

1/4M EJVV

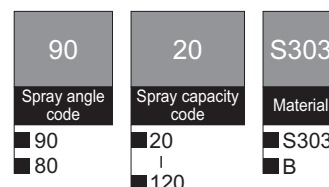

DDRP
series

Ultra-Thick Flat Spray Nozzles with Even Distribution

Steel making/ Rolling mill/
Plate mill

- Cooling
- Cleaning after pickling



FEATURES

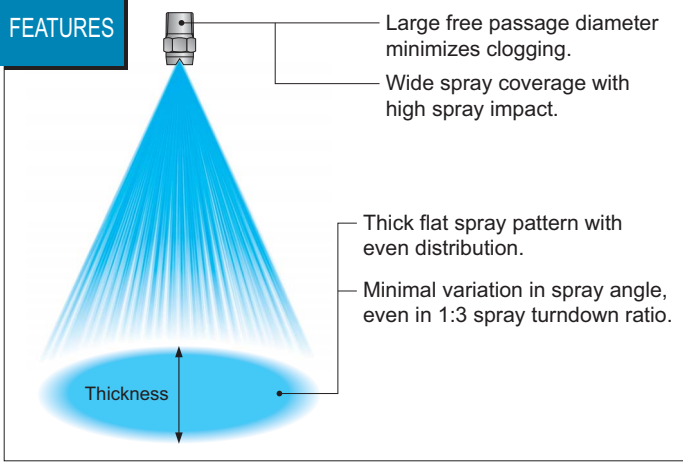

DDRP series

MATERIAL S303

STRUCTURE Simple one-piece structure to be screwed into a pipe, no whirler inside.

Pipe conn. size	Dimensions (mm)				Mass (g)
	L	H	øD	N	
Rc1/4	21	19	18	10.5	30
Rc3/8	26	21	19	11	40
Rc1/2	32	26	25	14	80
Rc3/4	40	32	31	15	140
Rc1	48	41	40	17	300

[Note] Appearance and dimensions may differ slightly depending on materials and nozzle codes.

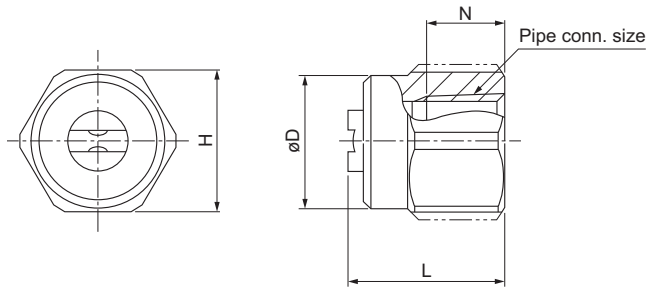

Spray angle code	Width	Thick-ness	Spray capacity code	Pipe conn. size	Spray angle (°) in width			Spray angle (°) in thickness			Spray capacity (ℓ/min)								Mean drop. dia. (µm)	Free pass. dia. (mm)		
					0.1 MPa	0.3 MPa	1 MPa	0.1 MPa	0.3 MPa	1 MPa	0.05 MPa	0.1 MPa	0.15 MPa	0.2 MPa	0.3 MPa	0.5 MPa	0.7 MPa	1 MPa			1.5 MPa	2 MPa
115	60	Rc1/4	50	112	115	116	58	60	60	2.15	2.98	3.61	4.13	5.00	6.42	7.57	9.02	11.0	12.7	300	1.4	
			100	113	115	116	58	60	60	4.31	5.97	7.22	8.26	10.0	12.8	15.1	18.0	22.0	25.3	390	2.0	
			120	113	115	116	58	60	60	5.17	7.16	8.66	9.92	12.0	15.4	18.2	21.6	26.4	30.4	460	2.2	
		140	113	115	116	58	60	60	6.03	8.35	10.1	11.6	14.0	18.0	21.2	25.3	30.8	35.5	670	2.4		
		200	113	115	116	58	60	60	8.62	11.9	14.4	16.5	20.0	25.7	30.3	36.1	44.0	50.7	430	2.9		
		260	113	115	116	58	60	60	11.2	15.5	18.8	21.5	26.0	33.4	39.4	46.9	57.2	65.9	460	3.3		
	90	45	Rc1/2	300	113	115	116	59	60	60	12.9	17.9	21.7	24.8	30.0	38.5	45.4	54.1	66.0	76.0	480	3.5
				500	113	115	116	59	60	60	21.5	29.8	36.1	41.3	50.0	64.2	75.7	90.2	110	127	550	4.5
				800	113	115	116	59	60	60	34.5	47.7	57.8	66.1	80.0	103	121	144	176	203	630	5.8
			1000	113	115	116	59	60	60	43.1	59.7	72.2	82.6	100	128	151	180	220	253	670	6.5	
			Rc3/8	50	88	90	90	42	45	45	2.15	2.98	3.61	4.13	5.00	6.42	7.57	9.02	11.0	12.7	310	1.4
				100	89	90	90	42	45	45	4.31	5.97	7.22	8.26	10.0	12.8	15.1	18.0	22.0	25.3	410	2.1
120	89	90		90	43	45	45	5.17	7.16	8.66	9.92	12.0	15.4	18.2	21.6	26.4	30.4	410	2.3			
Rc1/2	140	89	90	90	43	45	45	6.03	8.35	10.1	11.6	14.0	18.0	21.2	25.3	30.8	35.5	410	2.5			
	200	89	90	90	43	45	45	8.62	11.9	14.4	16.5	20.0	25.7	30.3	36.1	44.0	50.7	460	2.9			
	260	89	90	90	43	45	45	11.2	15.5	18.8	21.5	26.0	33.4	39.4	46.9	57.2	65.9	490	3.4			
Rc3/4	300	89	90	91	43	45	45	12.9	17.9	21.7	24.8	30.0	38.5	45.4	54.1	66.0	76.0	510	3.7			
	500	89	90	91	43	45	45	21.5	29.8	36.1	41.3	50.0	64.2	75.7	90.2	110	127	580	4.7			
	800	89	90	91	43	45	45	34.5	47.7	57.8	66.1	80.0	103	121	144	176	203	660	5.9			
Rc1	1000	89	90	91	43	45	45	43.1	59.7	72.2	82.6	100	128	151	180	220	253	700	6.3			

Conversion of unit [Pressure] 0.1 MPa ≈ 14.50 psi [Flow rate] 1 ℓ (liter) ≈ 0.26 US gal.
10 psi ≈ 0.07 MPa 1 US gal. ≈ 3.79 ℓ (liter)

How to order







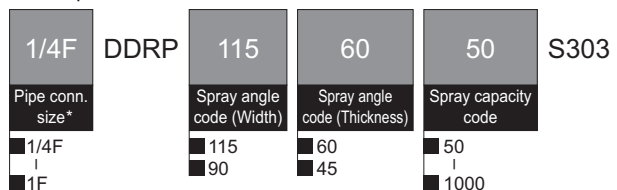

Please inquire or order for a specific nozzle using this coding system.









**M" indicates male thread (R) and "F" indicates female thread (Rc).
To order, please specify the pipe connection size by replacing respectively "R" and "Rc" by "M" and "F" as in the above chart.

<Example> 1/4F DDRP 115 60 50 S303



Spray Nozzles Lineup for Cast Steel Cooling

Series	DOVEA	DOVEA-W	DDA	VVP
Pneumatic or hydraulic	Pneumatic	Pneumatic	Pneumatic	Hydraulic
Spray pattern/distribution	Flat spray Even distribution	Thick flat spray Even distribution	Ultra-thick flat spray Even distribution	Flat spray Mountain-shaped distribution
Spray pattern image				
Spray distribution image (widthwise)				
Spray angle (°) (in thickness direction)	15–35	30–40	15–45	(5)
Turndown ratio ¹	1:30	1:20	1:10	1:2
Page of this catalog	pp.17–18	p.18	pp.19–20	pp.39–42

Series	WVVP	WVVEP	EJVJ	DDRP
Pneumatic or hydraulic	Hydraulic	Hydraulic	Hydraulic	Hydraulic
Spray pattern/distribution	Thick flat spray Mountain-shaped distribution	Thick flat spray Even distribution	Thick flat spray Even distribution	Ultra-thick flat spray Even distribution
Spray pattern image				
Spray distribution image (widthwise)				
Spray angle (°) (in thickness direction)	15–25	15–30	20–25	45–60
Turndown ratio ¹	1:2	1:3	1:3	1:3
Page of this catalog	p.43	p.45	p.46	p.47

*1) Turndown ratio is the ratio between adjustable minimum spray capacity and maximum spray capacity.

VV+YY series Dual Flat Spray Nozzles

Raw material process

Cleaning inner surface of bent pipe of coke oven

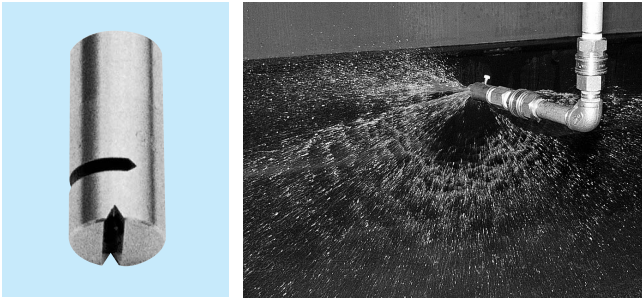

FEATURES

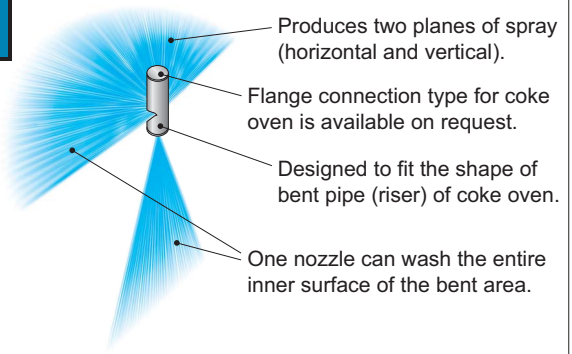

VV+YY nozzle used in bent pipe cleaning

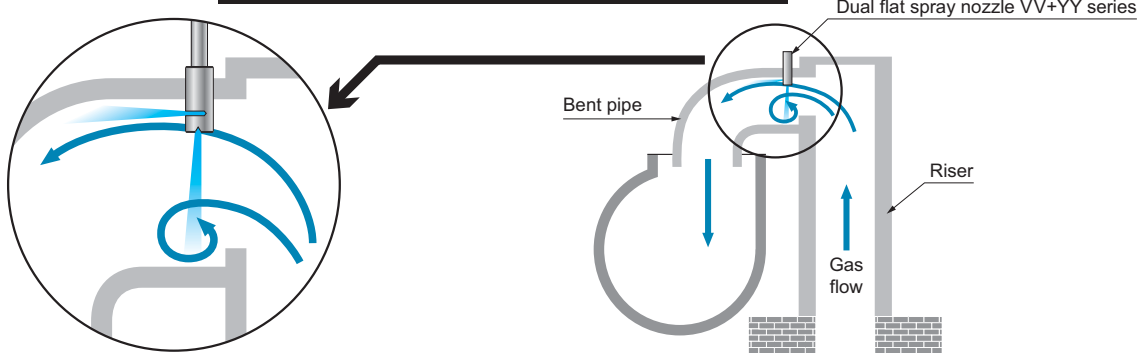

VV+YY series

<Reference of nozzle shape>

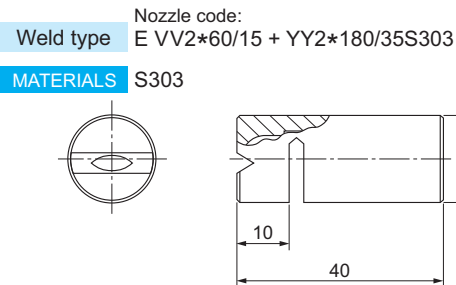
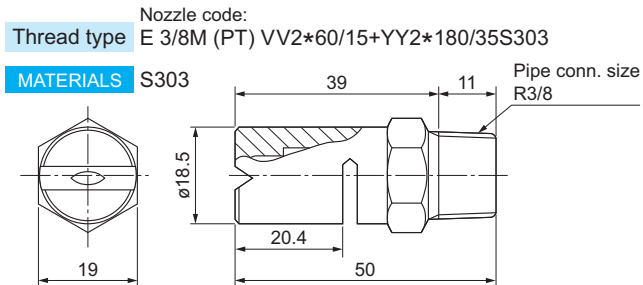

<Reference of spray pattern>

Nozzle code: E 3/8M (PT) VV2*60/15+YY2*180/35S303

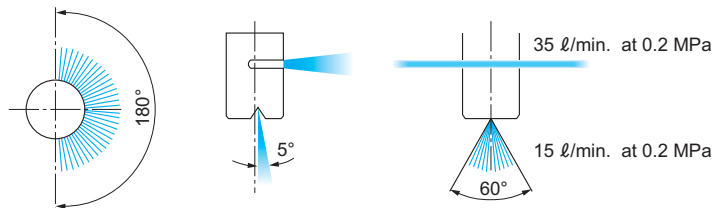

Nozzle code	Spray capacity (ℓ/min)							Spray capacity (ℓ/min) at 0.05 MPa (Reference only)	
	0.05 MPa	0.1 MPa	0.15 MPa	0.2 MPa	0.3 MPa	0.5 MPa	1 MPa	Down spray	Side spray
VV1.5*30/10+YY1.5*180/20	17.3	24.5	30.0	34.6	42.4	54.8	77.5	5.8	11.6
VV 2*60/15+YY 2*180/35	25.0	35.4	43.3	50.0	61.2	79.1	112	7.5	17.5
VV0.5*60/10+YY0.5*200/20	30.0	42.4	52.0	60.0	73.5	94.9	134	10	20
VV0.5*30/10+YY0.5*180/20	30.0	42.4	52.0	60.0	73.5	94.9	134	10	20

Conversion of unit [Pressure] 0.1 MPa ≈ 14.50 psi [Flow rate] 1 ℓ (liter) ≈ 0.26 US gal.
10 psi ≈ 0.07 MPa 1 US gal. ≈ 3.79 ℓ (liter)

How to order

Please contact our local sales office for details.

OVVEP series

Off-center Flat Spray Nozzles with Even Distribution

Rolling mill process

- Controlled cooling of plates
- Cooling of shaped steel

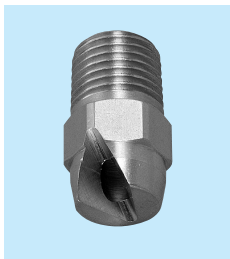

FEATURES

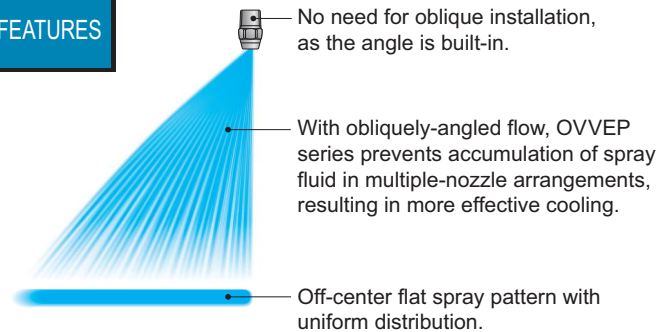

How to use OVVEP nozzles

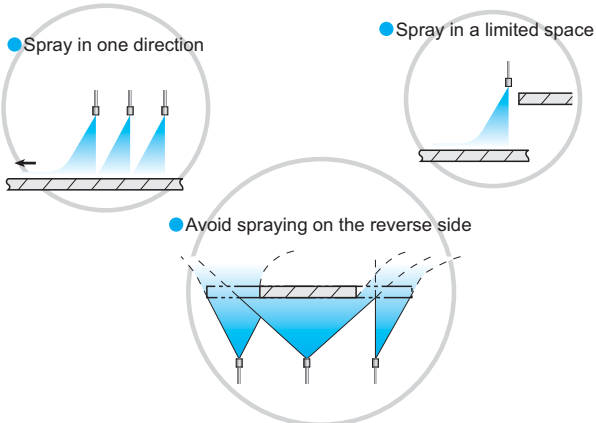

OVVEP series

MATERIALS S303 or B (Brass)

OPTIONAL MATERIAL: S316 or others

MASS S303: 17 g, B: 18 g

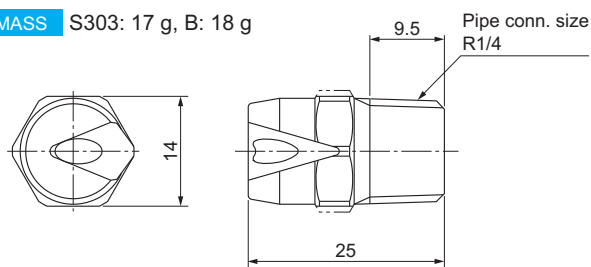

[Note] Appearance and dimensions may differ slightly depending on materials and nozzle codes.

Spray angle code	Spray capacity code	Spray angle (°)			Spray capacity (ℓ/min)										Mean drop. dia. (μm)	Free pass. dia. (mm)	
		0.05 MPa	0.3 MPa	0.7 MPa	0.05 MPa	0.07 MPa	0.1 MPa	0.15 MPa	0.2 MPa	0.3 MPa	0.5 MPa	0.7 MPa	1 MPa	1.5 MPa			2 MPa
60	200	56	60	62	8.2	9.7	11.5	14.1	16.3	20.0	25.8	30.6	36.5	44.7	21.6	540	2.4
	250	57	60	61	10.2	12.1	14.4	17.7	20.4	25.0	32.3	38.2	45.6	55.9	64.5	600	2.7
	300	57	60	61	12.2	14.5	17.3	21.2	24.5	30.0	38.7	45.8	54.8	67.1	77.5	670	3.0
45	200	41	45	48	8.2	9.7	11.5	14.1	16.3	20.0	25.8	30.6	36.5	44.7	21.6	600	3.2
	250	42	45	47	10.2	12.1	14.4	17.7	20.4	25.0	32.3	38.2	45.6	55.9	64.5	600	3.6
	300	42	45	47	12.2	14.5	17.3	21.2	24.5	30.0	38.7	45.8	54.8	67.1	77.5	750	4.0

How to order

Please inquire or order for a specific nozzle using this coding system.

<Example> 1/4M OVVEP 60 200 S303

1/4M OVVEP

60
Spray angle code
60
45

200
Spray capacity code
200
250
300

S303
Material
S303
B

Sister product

WOVVEP series

Off-center Thick Even Flat Spray Nozzles

Rolling mill process

- Cooling steel H-beam flanges
- Controlled cooling of plates



FEATURES

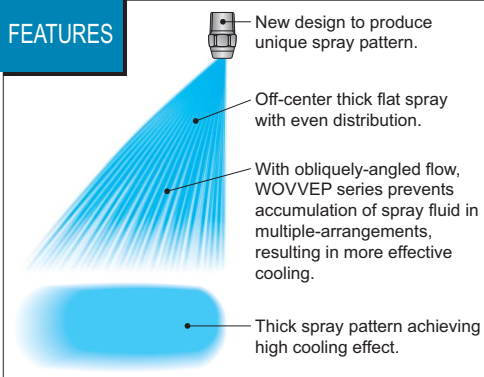

WOVVEP used in cooling applications

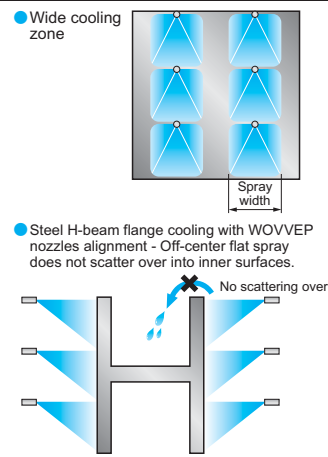

Please contact us for details.

MOMOJet® series Self-cleaning Flat Spray Nozzles

Cold rolling mill process

- Cooling steel plate
- Cleaning rolling mill



FEATURES

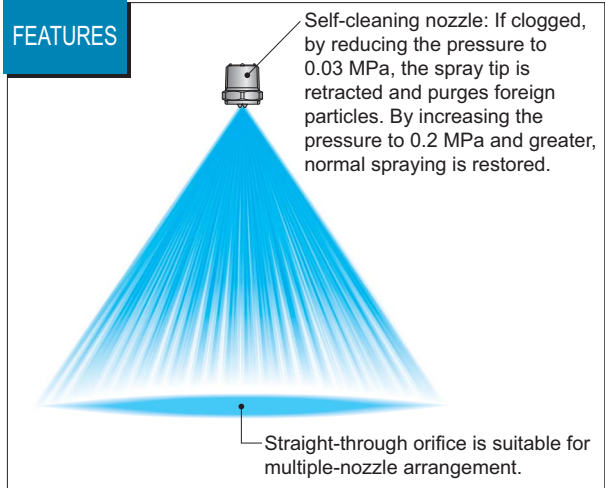

MOMOJet® series

MATERIAL S303

MASS 45 g

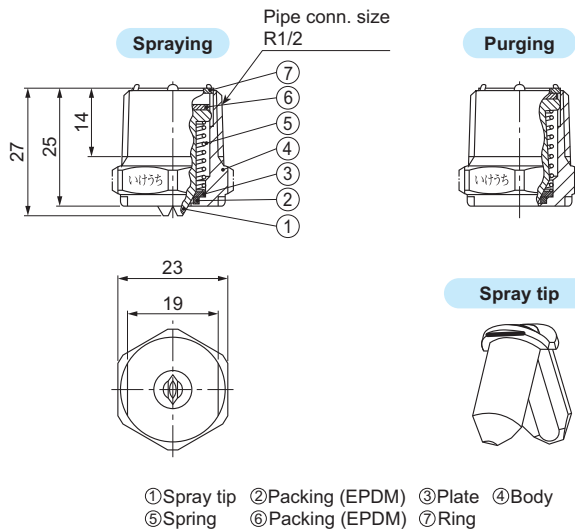

[Note] Appearance and dimensions may differ slightly depending on materials and nozzle codes.

Spray capacity code	Spray angle (°)		Spray capacity (ℓ/min)							Mean droplet diameter (μm)	Free passage diameter	
	0.3 MPa	0.7 MPa	0.2 MPa	0.3 MPa	0.5 MPa	0.7 MPa	1 MPa	1.5 MPa	2 MPa		Spraying (mm)	Purging (mm)
20	80	86	1.63	2.00	2.58	3.06	3.65	4.47	5.16	300	0.8	3.0
40	80	83	3.27	4.00	5.16	6.11	7.30	8.94	10.3	400	1.2	3.3
60	80	83	4.90	6.00	7.75	9.17	11.0	13.4	15.5	490	1.5	3.5

Cautions for use

- To start spraying a flow rate of about 9 ℓ/min at 0.05 MPa is required for all models because the spray tip opens wide. Select an appropriate pump.
- MOMOJet® is designed to start spraying at the pressure of 0.1 MPa. Use MOMOJet® at 0.2 MPa and greater.
- Since MOMOJet® series nozzles have active spray tips, the spray capacity is only guaranteed within +/-10% and the spray angle within +/-10° under standard pressure.

Conversion of unit [Pressure] 0.1 MPa ≈ 14.50 psi [Flow rate] 1 ℓ (liter) ≈ 0.26 US gal.
10 psi ≈ 0.07 MPa 1 US gal. ≈ 3.79 ℓ (liter)

How to order

Please inquire or order for a specific nozzle using this coding system.

<Example> 1/2 MOMO 8020 S303

1/2 MOMO 80 20 S303

Spray capacity code

- 20
- 40
- 60

ALSO AVAILABLE!

Self-cleaning
Solid Stream Jet
MOMOJet®"C"

For details, please refer to our hydraulic spray nozzle catalog.

INVV
series

Quick-detachable Standard Flat Spray Nozzles

Cold rolling mill process

- Pickling
- Pre- and post-treatment (Cleaning, rinsing, etc.)

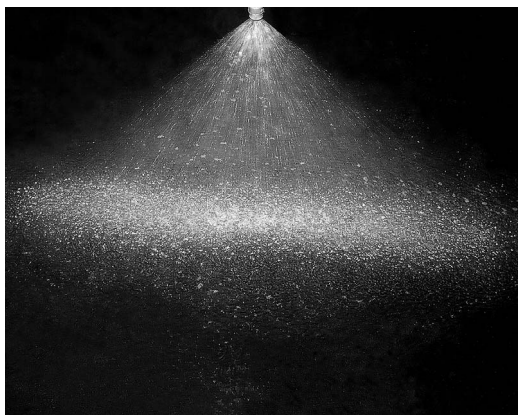

FEATURES

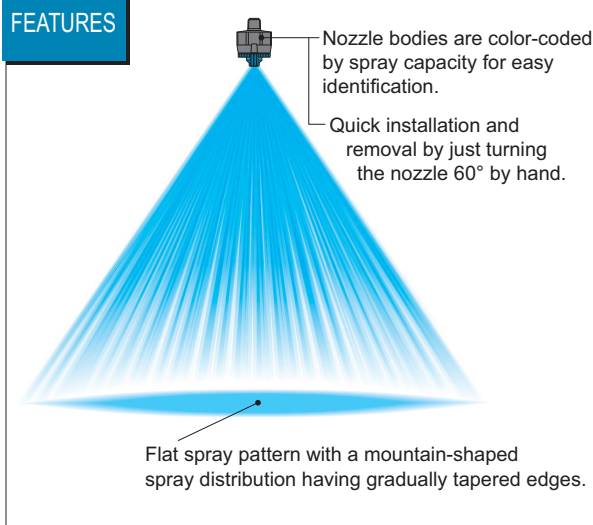

INVV series

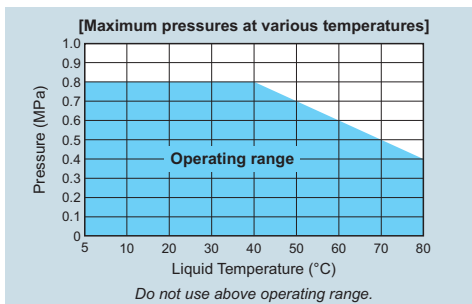

MATERIALS

- ① Nozzle tip: PP ② Packing: FEPM ③ Adaptor: PP or PPS

Pipe conn. size	Dimensions (mm)						Mass (g)	
	L ₁	L ₂	L ₃	W ₁	W ₂	N	PP	PPS
R1/8	10	27	37	30	27	8	9.0	12
R1/4	10	30	40	30	27	11.5	9.4	12
R3/8	10	30	40	30	27	12	10.3	14

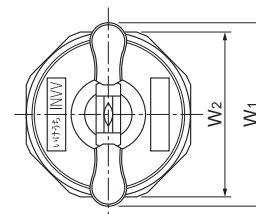
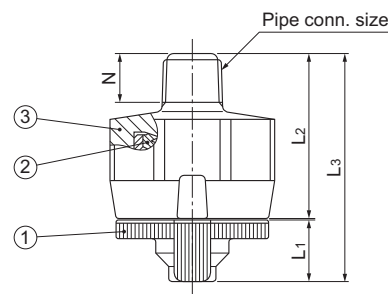

- ① Nozzle tip ② Packing ③ Adaptor

[Note]

- INVV series nozzles are not compatible with the discontinued ISVV series.
- Appearance and dimensions may differ slightly depending on materials and nozzle codes.

Spray angle code	Spray capacity code	Pipe connection size			Spray angle (°)			Spray capacity (ℓ/min)							Mean droplet dia. (μm)	Free passage dia. (mm)	Color of nozzle tip	
		R1/8	R1/4	R3/8	0.15 MPa	0.3 MPa	0.7 MPa	0.05 MPa	0.1 MPa	0.15 MPa	0.2 MPa	0.3 MPa	0.5 MPa	0.7 MPa				
115	05	○	○	○	102	115	124	—	0.29	0.35	0.41	0.50	0.65	0.76	160	0.3	Green	
	07	○	○	○	103	115	124	—	0.40	0.49	0.57	0.70	0.90	1.07			0.3	Brown
	10	○	○	○	103	115	124	0.41	0.58	0.71	0.82	1.00	1.29	1.53			0.4	Red
	15	○	○	○	104	115	123	0.61	0.87	1.06	1.23	1.50	1.94	2.29			0.5	Gray
	20	○	○	○	104	115	123	0.82	1.15	1.41	1.63	2.00	2.58	3.06			0.6	Black
	30	○	○	○	105	115	122	1.23	1.73	2.12	2.45	3.00	3.88	4.58			0.8	Blue
	40	○	○	○	106	115	122	1.63	2.31	2.83	3.27	4.00	5.16	6.11			0.8	Yellow
90	05	○	○	○	77	90	100	—	0.29	0.35	0.41	0.50	0.65	0.76	170	0.3	Green	
	07	○	○	○	78	90	100	—	0.40	0.49	0.57	0.70	0.90	1.07			0.4	Brown
	10	○	○	○	78	90	99	0.41	0.58	0.71	0.82	1.00	1.29	1.53			0.5	Red
	15	○	○	○	79	90	99	0.61	0.87	1.06	1.23	1.50	1.94	2.29			0.6	Gray
	20	○	○	○	79	90	98	0.82	1.15	1.41	1.63	2.00	2.58	3.06			0.7	Black
	30	○	○	○	80	90	97	1.23	1.73	2.12	2.45	3.00	3.88	4.58			0.9	Blue
	40	○	○	○	81	90	97	1.63	2.31	2.83	3.27	4.00	5.16	6.11			1.1	Yellow
50	○	○	○	81	90	97	2.04	2.89	3.54	4.08	5.00	6.46	7.64	300	1.2	Pink		

INVV series
Quick-detachable Standard Flat Spray Nozzles

Spray angle code	Spray capacity code	Pipe connection size			Spray angle (°)			Spray capacity (ℓ/min)							Mean droplet dia. (μm)	Free passage dia. (mm)	Color of nozzle tip
		R1/8	R1/4	R3/8	0.15 MPa	0.3 MPa	0.7 MPa	0.05 MPa	0.1 MPa	0.15 MPa	0.2 MPa	0.3 MPa	0.5 MPa	0.7 MPa			
65	05	○	○	○	52	65	74	—	0.29	0.35	0.41	0.50	0.65	0.76	190	0.4	Green
	07	○	○	○	53	65	74	—	0.40	0.49	0.57	0.70	0.90	1.07		0.5	Brown
	10	○	○	○	54	65	73	0.41	0.58	0.71	0.82	1.00	1.29	1.53		0.6	Red
	15	○	○	○	54	65	73	0.61	0.87	1.06	1.23	1.50	1.94	2.29		0.8	Gray
	20	○	○	○	55	65	72	0.82	1.15	1.41	1.63	2.00	2.58	3.06		0.9	Black
	30	○	○	○	56	65	72	1.23	1.73	2.12	2.45	3.00	3.88	4.58		1.1	Blue
	40	○	○	○	56	65	71	1.63	2.31	2.83	3.27	4.00	5.16	6.11		1.3	Yellow
50	○	○	○	57	65	71	2.04	2.89	3.54	4.08	5.00	6.46	7.64	1.5	Pink		
50	05	○	○	○	38	50	59	—	0.29	0.35	0.41	0.50	0.65	0.76	210	0.4	Green
	07	○	○	○	38	50	58	—	0.40	0.49	0.57	0.70	0.90	1.07		0.5	Brown
	10	○	○	○	40	50	58	0.41	0.58	0.71	0.82	1.00	1.29	1.53		0.6	Red
	15	○	○	○	40	50	57	0.61	0.87	1.06	1.23	1.50	1.94	2.29		0.8	Gray
	20	○	○	○	41	50	57	0.82	1.15	1.41	1.63	2.00	2.58	3.06		1.0	Black
	30	○	○	○	42	50	56	1.23	1.73	2.12	2.45	3.00	3.88	4.58		1.2	Blue
	40	○	○	○	42	50	56	1.63	2.31	2.83	3.27	4.00	5.16	6.11		1.4	Yellow
50	○	○	○	43	50	55	2.04	2.89	3.54	4.08	5.00	6.46	7.64	1.6	Pink		

Conversion of unit [Pressure] 0.1 MPa ≈ 14.50 psi [Flow rate] 1 ℓ (liter) ≈ 0.26 US gal.
10 psi ≈ 0.07 MPa 1 US gal. ≈ 3.79 ℓ (liter)

How to order

Please inquire or order for a specific nozzle using this coding system.

① Complete unit

<Example> 1/8M INVV 90 30 PP(FEPM)+PP

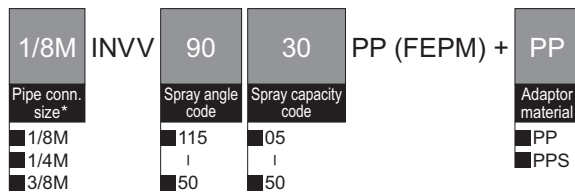

② Nozzle tip only

<Example> INVV 90 30 PP(FEPM)

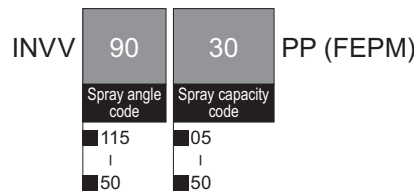

*"M" indicates male thread ("R" of the ISO standard) and "F" indicates female thread ("Rc" of the ISO standard).
To order, please specify the pipe connection size by replacing respectively "R" and "Rc" by "M" and "F" as in the above chart.

ALSO AVAILABLE!

Quick-detachable
Full Cone
Spray Nozzles
INJXX
series

For details, please refer to our hydraulic spray nozzle catalog.

JJXP
series

Standard Full Cone Spray Nozzles

Iron making process

- Gas temperature control at the top of furnace

Steel making process

- Cooling steel in CCM
- Cooling shell and cover of electric furnace

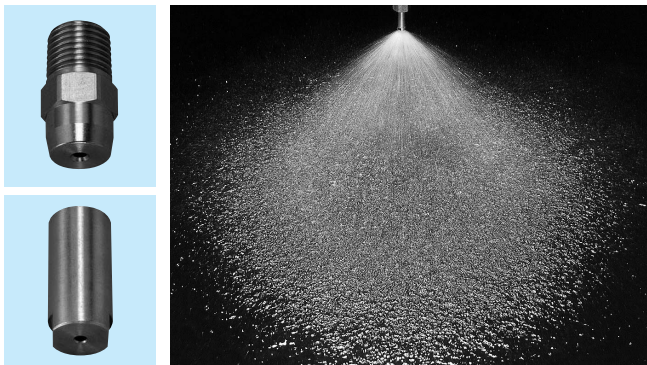

FEATURES

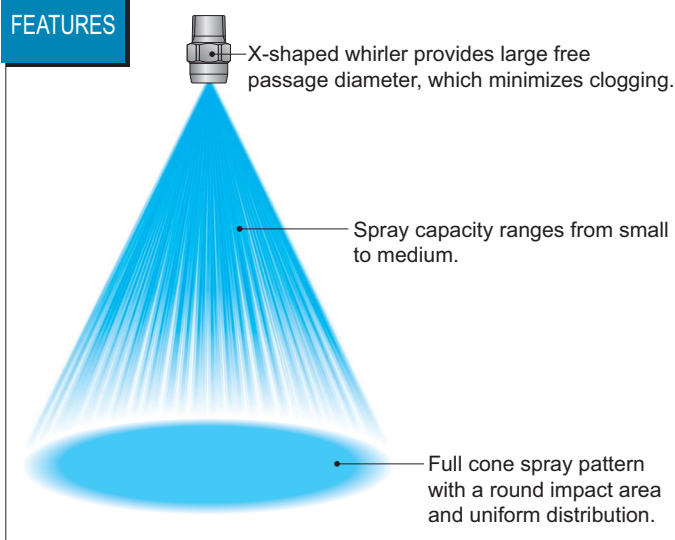

JJXP series

MATERIALS

- Sizes R1/8–R3/8 (Rc3/8): S303
- Sizes Rc1/2–Rc1: S303 or B (brass)
- Sizes Rc1*1/2 or larger: S316
- Whirler material is mainly S316L equivalent, but depending on nozzle codes, S316 equivalent or SCS16 whirlers are used.

OPTIONAL MATERIAL:

S316, S316L,
PP, PTFE (for Rc3/8 sizes and over)

Thread size of optional material may differ depending on materials.

Pipe conn. size ^{*1}	Dimensions (mm)							Mass (g)	
	L ₁	L ₂	L ₃	H	W	øD	N	S303 S316	B
R1/8 (005)	20	32.5	—	12	—	—	7	9.5 ^{*2}	—
R1/8 (010–030)	20	—	—	12	—	—	7	11	—
R1/4 (005)	20	32.5	—	14	—	—	10.5	18	—
R1/4 (010–030)	20	—	—	14	—	—	10.5	18	—
R1/4 (040–060)	28	—	—	14	—	—	10.5	21	—
R3/8	34	—	6	—	17	20	11	50	—
Rc3/8	43	—	6	—	17	20	11	61	—
Rc1/2	54	—	8	—	22	25	14	140	150
Rc3/4	69	—	10	—	27	32	15	270	290
Rc1	89	—	14	—	34	40	17	515	550
Rc1*1/2	124	—	20	—	50	58	19	1,520	—
Rc2 (250–350)	160	—	24	—	60	70	23	2,600	—
Rc2 (400–500)	118.5	—	24	—	60	70	23	2,050	—
Rc2*1/2	147.5	—	27	—	80	90	27	4,360	—
Rc3 (920)	163.5	—	30	—	90	105	30	6,700	—
Rc3 (1200)	170.5	—	30	—	90	105	30	6,500	—

*1) Figures in () after the pipe connection sizes indicate the spray capacity codes.

*2) For JJXP005 with strainer, add 2 g to the above mass.

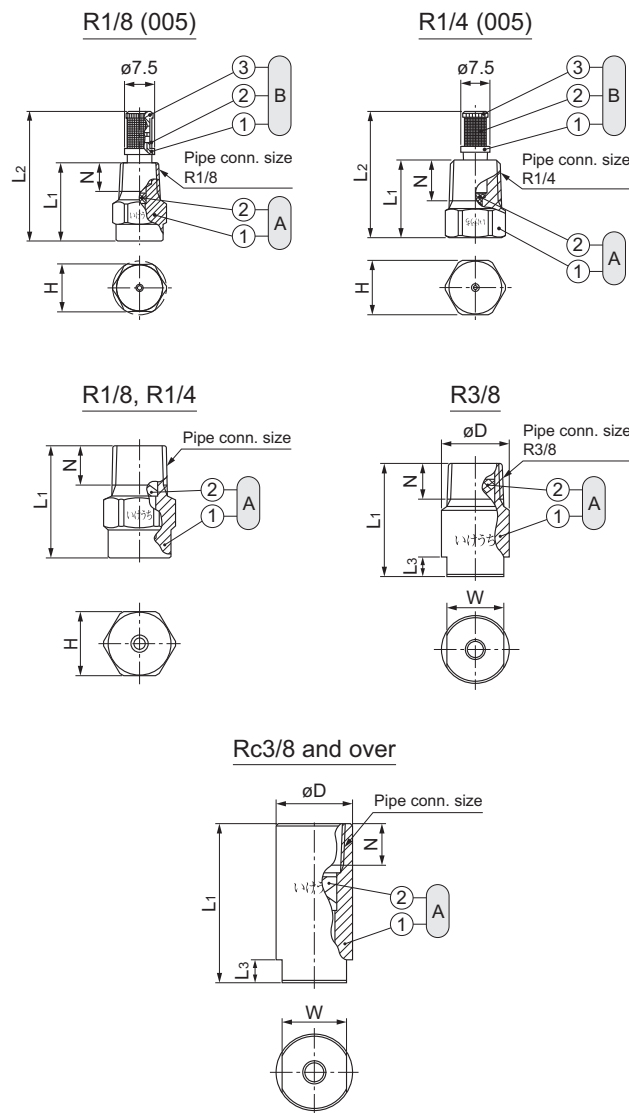

Ⓐ Nozzle (1)Body (2)Whirler

Ⓑ Strainer (1)Strainer holder (2)Strainer screen [S316] (3)Strainer cap

[Note] Appearance and dimensions may differ slightly depending on materials and nozzle codes.

JJXP series
Standard Full Cone Spray Nozzles

Spray capacity code	Pipe connection size				Spray angle (°)			Spray capacity (ℓ/min)								Mean drop. dia. (μm)	Free pass. dia. (mm)	
	R1/8	R1/4	R3/8	Rc3/8	0.05 MPa	0.2 MPa	0.5 MPa	0.03 MPa	0.05 MPa	0.1 MPa	0.15 MPa	0.2 MPa	0.3 MPa	0.5 MPa	0.7 MPa			1 MPa
005	●	●			—	55	65	—	—	0.36	0.44	0.50	0.59	0.73	0.83	0.96	270	0.4
010	○	○			50	55	45	—	0.53	0.73	0.88	1.00	1.18	1.45	1.67	1.93	290	0.7
015	○	○			60	65	55	—	0.79	1.09	1.32	1.50	1.77	2.18	2.50	2.89		0.8
020	○	○			60	65	55	—	1.06	1.46	1.75	2.00	2.36	2.91	3.34	3.86		1.4
030	○	○			65	70	60	—	1.59	2.18	2.63	3.00	3.54	4.36	5.00	5.79	410	1.4
040		○			60	65	55	—	2.12	2.91	3.51	4.00	4.72	5.81	6.67	7.72	380	1.7
050		○			65	70	60	—	2.65	3.64	4.38	5.00	5.90	7.27	8.34	9.64		1.7
060		○			70	75	65	2.51	3.18	4.37	5.26	6.00	7.08	8.72	10.0	11.6	520	1.7
070			○	○	60	65	60	2.93	3.71	5.09	6.13	7.00	8.26	10.2	11.7	13.5	480	1.9
080			○	○	65	70	65	3.35	4.24	5.82	7.01	8.00	9.44	11.6	13.3	15.4		1.9
10			○	○	75	80	75	4.19	5.29	7.28	8.76	10.0	11.8	14.5	16.7	19.3		2.6
12			○	○	80	85	80	5.03	6.35	8.73	10.5	12.0	14.2	17.4	20.0	23.1	660	2.6

Spray capacity code	Pipe connection size							Spray angle (°)			Spray capacity (ℓ/min)								Mean drop. dia. (μm)	Free pass. dia. (mm)	
	Rc 1/2	Rc 3/4	Rc 1	Rc 1 1/2	Rc 2	Rc 2 1/2	Rc 3	0.05 MPa	0.2 MPa	0.5 MPa	0.03 MPa	0.05 MPa	0.1 MPa	0.15 MPa	0.2 MPa	0.3 MPa	0.5 MPa	0.7 MPa			1 MPa
14	○							65	70	55	5.86	7.41	10.2	12.3	14.0	16.5	20.3	23.3	27.0	590	3.5
16	○							70	75	60	6.70	8.47	11.6	14.0	16.0	18.9	23.3	26.7	30.9		3.5
18	○							75	80	65	7.54	9.53	13.1	15.8	18.0	21.2	26.2	30.0	34.7		3.5
20	○							80	85	70	8.38	10.6	14.6	17.5	20.0	23.6	29.1	33.4	38.6	740	3.5
23		○						70	75	60	9.63	12.2	16.7	20.2	23.0	27.1	33.4	38.4	44.4	630	4.7
26		○						75	80	65	10.9	13.8	18.9	22.8	26.0	30.7	37.8	43.4	50.1		4.7
30		○						80	85	70	12.6	15.9	21.8	26.3	30.0	35.4	43.6	50.0	57.9		4.7
35		○						85	90	75	14.7	18.5	25.5	30.7	35.0	41.3	50.9	58.4	67.5		4.7
40		○						90	95	80	16.8	21.2	29.1	35.1	40.0	47.2	58.1	66.7	77.2		4.7
45		○						90	95	80	18.8	23.8	32.7	39.4	45.0	53.1	65.4	75.0	86.8	950	4.7
50			○					70	75	60	20.9	26.5	36.4	43.8	50.0	59.0	72.7	83.4	96.4	800	6.0
60			○					80	85	70	25.1	31.8	43.7	52.6	60.0	70.8	87.2	100	116		6.0
80			○					90	95	80	33.5	42.4	58.2	70.1	80.0	94.4	116	133	154		6.0
90			○					90	95	80	37.7	47.7	65.5	78.9	90.0	106	131	150	174	1,150	6.6
100				○				80	85	70	41.9	52.9	72.8	87.6	100	118	145	167	193	1,000	8.4
150				○				85	90	75	62.8	79.4	109	131	150	177	218	250	289		10.3
200				○				90	95	80	83.8	106	146	175	200	236	291	334	386	1,350	10.3
250					○			85	90	75	105	132	182	219	250	295	363	417	482	1,200	12.7
300					○			90	95	80	126	159	218	263	300	354	436	500	579		12.7
350					○			90	95	80	147	185	255	307	350	413	509	584	675		12.7
400					○			75	80	65	168	212	291	351	400	472	581	667	772		13.2
500					○			95	95	80	209	265	364	438	500	590	727	834	964	1,500	13.2
600						○		75	80	65	251	318	437	526	600	708	872	1,001	1,157	1,500	16.9
700						○		85	90	75	293	371	509	613	700	826	1,017	1,167	1,350	1,800	16.9
920							○	100	100	85	385	487	669	806	920	1,086	1,337	1,534	1,775	1,660	18.1
1200							○	105	105	90	503	635	873	1,052	1,200	1,416	1,744	2,001	2,315	1,950	20.0

●: With strainer (mesh size #100) ○: Without strainer

Conversion of unit [Pressure] 0.1 MPa ≈ 14.50 psi [Flow rate] 1 ℓ (liter) ≈ 0.26 US gal.
10 psi ≈ 0.07 MPa 1 US gal. ≈ 3.79 ℓ (liter)

For spraying slurry, the nozzle material should be wear-resistant.
For this purpose, the JJXP-AL92 series nozzles made of high-purity alumina are available (see page 58).

How to order

Please inquire or order for a specific nozzle using this coding system.

<Example> 1/8M JJXP 005 S303 W

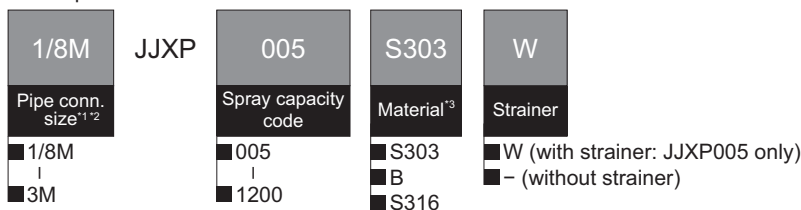

*1) "M" indicates male thread ("R" of the ISO standard) and "F" indicates female thread ("Rc" of the ISO standard).

To order, please specify the pipe connection size by replacing respectively "R" and "Rc" by "M" and "F" as in the above chart.

*2) When spray capacity code is 005–030, pipe connection size for R1/4 is indicated as "1/4x1/8M".

*3) See "MATERIALS" information on page 54 for standard materials by each size.

AJP series

Clog-resistant Vaneless Full Cone Spray Nozzles

Raw material process

- Gas absorption in flue gas desulfurization
- Cleaning of precipitator electrodes
- Spraying ammonia water in bent pipe

Steel making process

- Cooling shell and cover of electric furnace

Rolling mill process

- Controlled cooling of reverse side of steel
- Spray cooling in continuous annealing

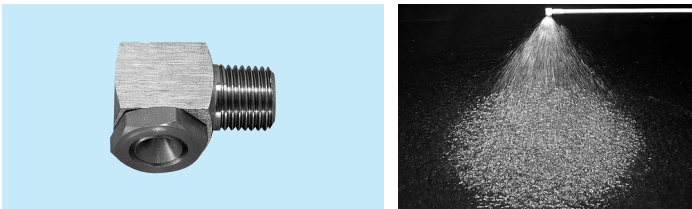

FEATURES

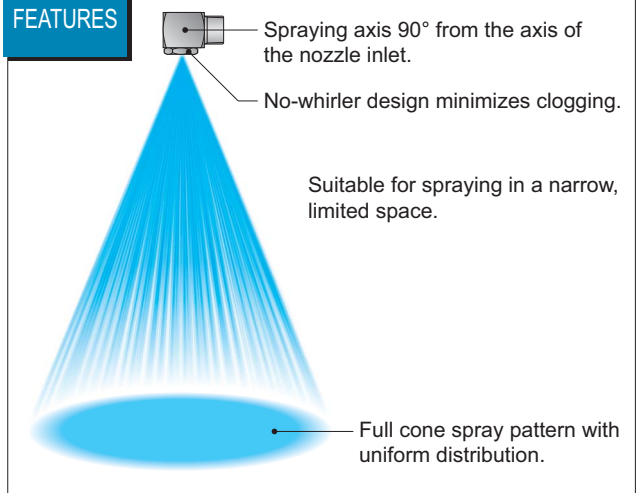

Free passage diameter comparison: AJP series vs. other full cone spray nozzles

Due to its unique vaneless design (no blockages inside nozzle), AJP series has the largest free passage diameter of all of our full cone spray nozzles. This is why AJP series nozzles are ideal for applications where clogging is a concern such as spraying slurry.

- Conventional full cone spray nozzles
- AJP series nozzles

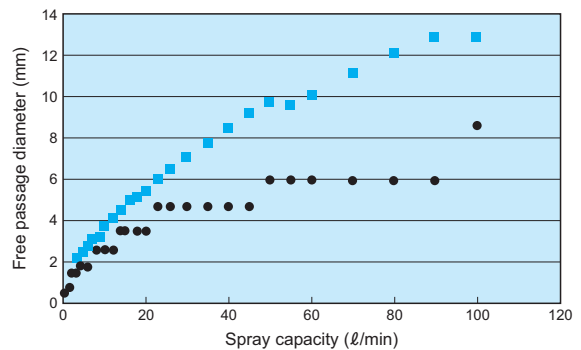

AJP series

R1/8

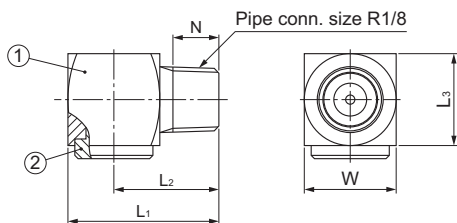

R1/4, R3/4, R1, R1*1/2

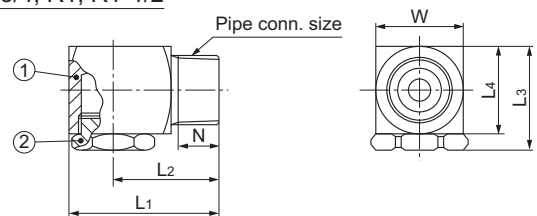

MATERIALS ① Body: S304, S303, or SCS13 (vary by nozzle code)
② Orifice cap: S303

OPTIONAL MATERIAL: S316

Pipe conn. size	Dimensions (mm)						Mass (g)
	L1	L2	L3	L4	W	N	
R1/8	23	16	14	—	14	7	25
R1/4	32	23	20.5	16	16	10.5	55
R3/8	36	26	23.5	19	20	11	70
R1/2	46	33.5	31	25	25	14	180
R3/4	55	39	38	32	32	15	340
R1	70	50	48	40	40	18	670
R1*1/2	100	70	72	58.5	58.5	20	2,400

R3/8, R1/2

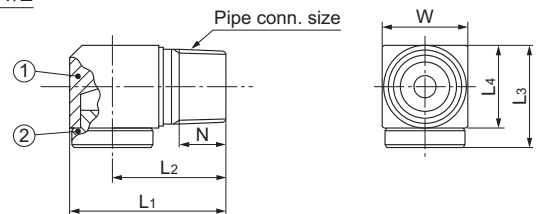

① Nozzle body ② Cap

[Note] Appearance and dimensions may differ slightly depending on materials and nozzle codes.

Spray capacity code	Pipe connection size							Spray angle (°)			Spray capacity (ℓ/min)							Mean droplet diameter (μm)	Free passage diameter (mm)
	R1/8	R1/4	R3/8	R1/2	R3/4	R1	R1*1/2	0.05 MPa	0.2 MPa	0.5 MPa	0.03 MPa	0.05 MPa	0.1 MPa	0.15 MPa	0.2 MPa	0.3 MPa	0.5 MPa		
	○	○	○	○	○	○	○	—	75	69	—	1.02	1.43	1.74	2.00	2.35	2.89		
02	○							64	75	69	—	1.02	1.43	1.74	2.00	2.35	2.89	640	1.6
03	○							65	75	69	—	1.53	2.14	2.61	3.00	3.53	4.33		
04		○						65	75	68	1.59	2.04	2.86	3.48	4.00	4.70	5.77	1	2.2
05		○						65	75	68	1.99	2.55	3.57	4.35	5.00	5.88	7.21		
06		○						70	80	73	2.39	3.06	4.29	5.22	6.00	7.06	8.66	1	2.8
07		○						70	80	73	2.79	3.57	5.00	6.09	7.00	8.23	10.1		

AJP series
Clog-resistant Vaneless Full Cone Spray Nozzles

Spray capacity code	Pipe connection size							Spray angle (°)			Spray capacity (ℓ/min)						Mean droplet diameter (μm)	Free passage diameter (mm)	
	R1/8	R1/4	R3/8	R1/2	R3/4	R1	R1*1/2	0.05 MPa	0.2 MPa	0.5 MPa	0.03 MPa	0.05 MPa	0.1 MPa	0.15 MPa	0.2 MPa	0.3 MPa			0.5 MPa
08			○					70	80	73	3.19	4.08	5.71	6.96	8.00	9.54	11.9	740	3.2
10			○					70	80	73	3.98	5.10	7.14	8.70	10.0	11.9	14.9		3.7
12			○					75	85	78	4.78	6.12	8.57	10.4	12.0	14.3	17.9	820	4.1
14			○					75	85	78	5.57	7.14	10.0	12.2	14.0	16.7	20.9		4.5
16			○					75	85	78	6.37	8.16	11.4	13.9	16.0	19.1	23.8	5.0	
18				○				76	85	79	7.17	9.18	12.9	15.7	18.0	21.6	27.1	900	5.1
20				○				76	85	79	7.96	10.2	14.3	17.4	20.0	23.9	30.1		5.4
23				○				76	85	79	9.16	11.7	16.4	20.0	23.0	27.5	34.6	6.0	
26				○				76	85	79	10.4	13.3	18.6	22.6	26.0	31.1	39.1	6.5	
30				○				76	85	79	11.9	15.3	21.4	26.1	30.0	35.9	45.1	7.1	
35				○				83	90	85	13.9	17.9	25.0	30.4	35.0	41.9	52.6	7.8	
40				○				83	90	85	15.9	20.4	28.6	34.8	40.0	47.9	60.1	8.5	
45				○				83	90	85	17.9	23.0	32.1	39.1	45.0	53.9	67.6	9.2	
50				○				83	90	85	19.9	25.5	35.7	43.5	50.0	59.9	75.1	9.8	
55					○			83	90	85	21.9	28.1	39.3	47.8	55.0	65.9	82.6	1,000	9.6
60					○			83	90	85	23.9	30.6	42.9	52.2	60.0	71.8	90.2		10.1
70					○			83	90	85	27.9	35.7	50.0	60.9	70.0	83.8	105	11.2	
80					○			83	90	85	31.9	40.8	57.1	69.6	80.0	95.8	120	12.2	
90					○			83	90	85	35.8	45.9	64.3	78.3	90.0	108	135	13.0	
100						○		83	90	85	39.8	51.0	71.4	87.0	100	120	150	1,120	13.0
120						○		83	90	85	47.8	61.2	85.7	104	120	144	180		14.8
150						○		83	90	85	59.7	76.5	107	130	150	180	225	17.4	
180							○	83	90	85	71.7	91.8	129	157	180	216	270	1,280	17.8
200							○	83	90	85	79.6	102	143	174	200	239	301		18.8
250							○	83	90	85	99.5	128	179	217	250	299	376	22.3	

Conversion of unit [Pressure] 0.1 MPa ≈ 14.50 psi [Flow rate] 1 ℓ (liter) ≈ 0.26 US gal.
10 psi ≈ 0.07 MPa 1 US gal. ≈ 3.79 ℓ (liter)

How to order

Please inquire or order for a specific nozzle using this coding system.

**"M" indicates male thread (R) and "F" indicates female thread (Rc).
To order, please specify the pipe connection size by replacing respectively "R" and "Rc" by "M" and "F" as in the above chart.

<Example> 1/4M AJP 04 S303

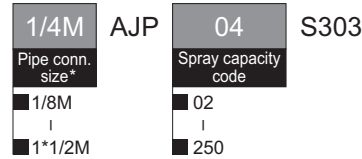

Sister product

Wide angle
AJP series

Clog-resistant Wide-angle Full Cone Spray Nozzles

Steel making process

● Cooling of electric furnace cover



FEATURES

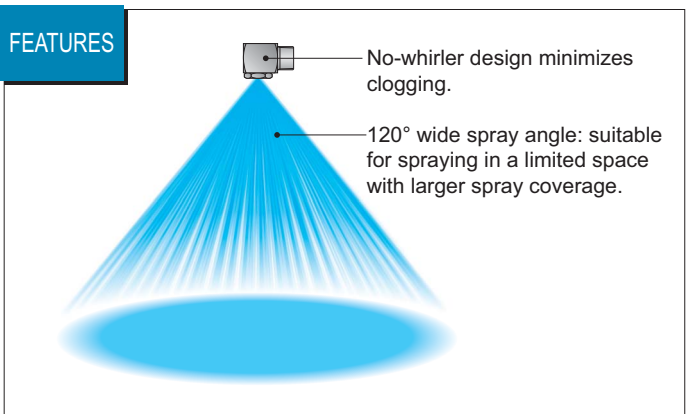

Spray capacity code	Pipe connection size		Spray angle (°)			Spray capacity (ℓ/min)						
	R1/4	R3/4	0.03 MPa	0.15 MPa	0.5 MPa	0.03 MPa	0.05 MPa	0.1 MPa	0.15 MPa	0.2 MPa	0.3 MPa	0.5 MPa
1.5*120/7 0.3*120/21	○	○	115 120	120 114	110 110	3.20 21.0	4.11 26.9	5.75 37.7	7.00 45.9	8.05 52.7	9.47 63.2	11.6 79.3

How to order

Please inquire or order for a specific nozzle using these product codes.

E 1/4M(PT)AJP1.5*120/7S303 or E 3/4M(PT)AJP0.3*120/21S303

TAA series Wear-resistant Large Capacity Hollow Cone Spray Nozzles

Raw material process

- Gas absorption in flue gas desulfurization

Iron making process

- Recycled water spraying in water granulation process (spraying in cooling tower)

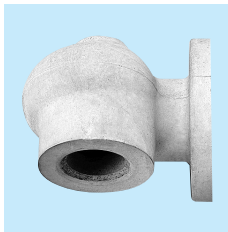

TAA series available range

Flange connection size (inches)	at pressure of 0.07 MPa		Free passage diameter (mm)
	Spray angle (°)	Spray capacity (ℓ/min)	
2	67	200–300	28–33
3	67–80	400–800	38–57
4	80	1,000–1,200	63–68

Conversion of unit [Pressure] 0.1 MPa ≈ 14.50 psi [Flow rate] 1 ℓ (liter) ≈ 0.26 US gal.
10 psi ≈ 0.07 MPa 1 US gal. ≈ 3.79 ℓ (liter)

FEATURES

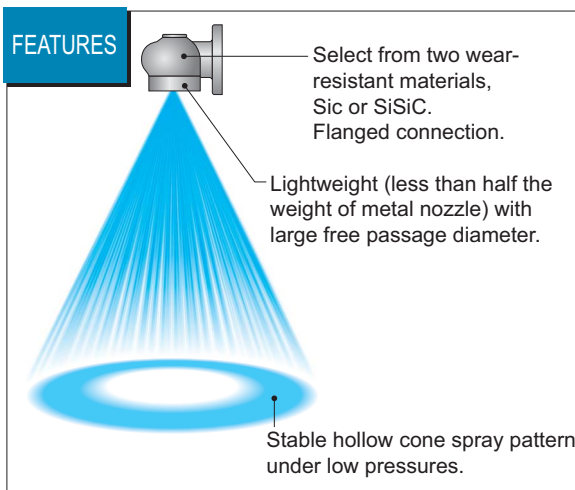

TWAA series Wear-resistant Bi-directional Hollow Cone Spray Nozzles

Raw material process

- Gas absorption in flue gas desulfurization

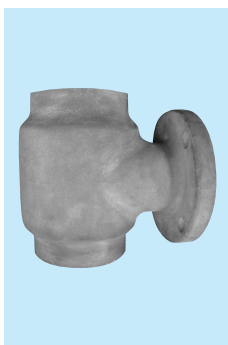

TWAA series available range

Standard pressure: 0.07 MPa
Spray capacity range: 200–1200 ℓ/min
Connection flange size: 2–4 inches

FEATURES

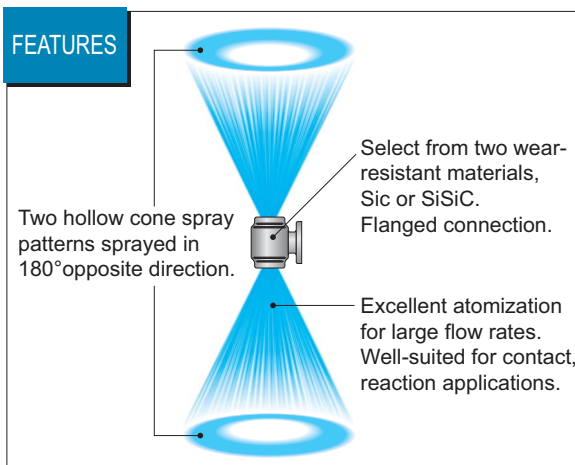

JUXP series Wear-resistant Full Cone Spray Nozzles

Raw material process

- Gas absorption in flue gas desulfurization



(JUXP-AL92 nozzle w/ S316 socket)

JUXP series available range

Pipe connection size (inches)	at pressure of 0.2 MPa	
	Spray angle (°)	Spray capacity (ℓ/min)
Rc3/4	75–95	23–45
Rc1	75–95	23–90
Rc1*1/2	75–95	50–200
Rc2	85–100	100–550
Rc2*1/2	80–100	250–700
Rc3	80–90	600–700

Conversion of unit [Pressure] 0.1 MPa ≈ 14.50 psi [Flow rate] 1 ℓ (liter) ≈ 0.26 US gal.
10 psi ≈ 0.07 MPa 1 US gal. ≈ 3.79 ℓ (liter)

FEATURES

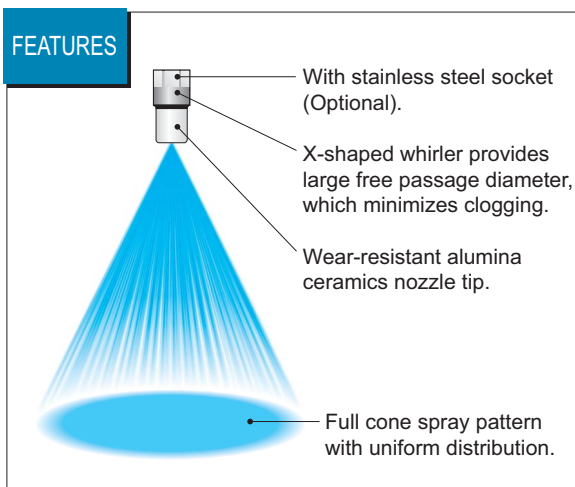

How to order

Please contact our local sales office for details.

BBXP
series

Wide-angle Full Cone Spray Nozzles

Iron making process

- Gas temperature control at the top of furnace

Steel making process

- Cooling steel in CCM

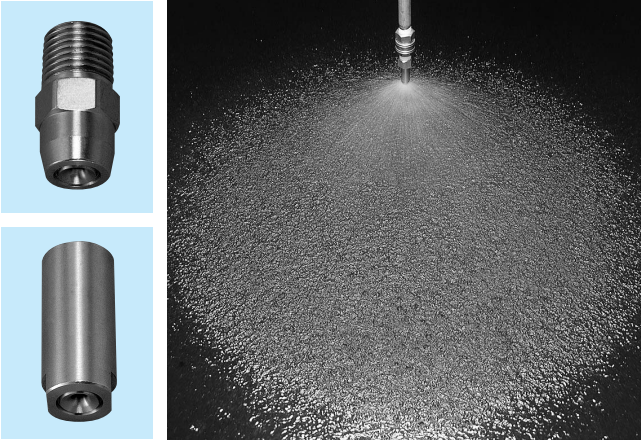

FEATURES

X-shaped whirler provides large free passage diameter, which minimizes clogging.

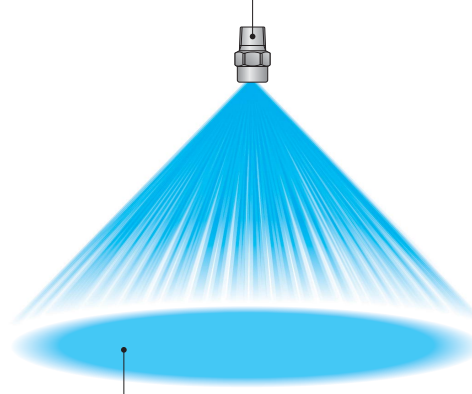

Full cone spray pattern with wide spray angle 120°.

BBXP series

MATERIALS

- Sizes R1/8–R3/8 (Rc3/8): S303
- Sizes Rc1/2–Rc1: S303 or B (brass)
- Sizes Rc1*1/2 or larger: S316

OPTIONAL MATERIAL: S316L or others

R1/8, R1/4

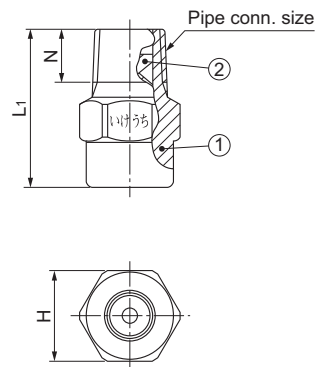

R3/8

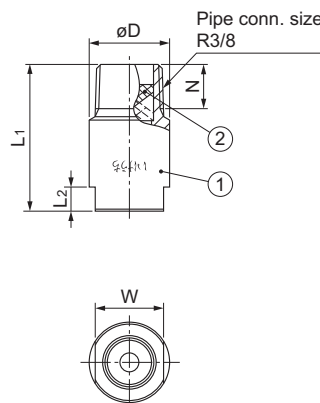

Rc3/8 and over

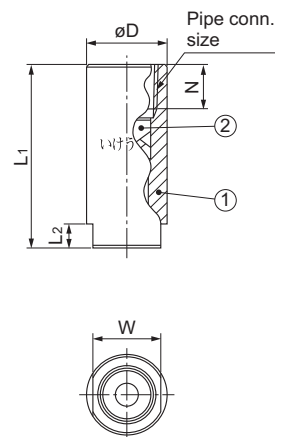

Pipe conn. size	Dimensions (mm)						Mass (g)		
	L1	L2	H	W	øD	N	S303	S316	B
R1/8	21	—	12	—	—	7	11	—	—
R1/4 (015, 020)	21	—	14	—	—	10.5	20	—	—
R1/4 (030)	21.5	—	14	—	—	10.5	20	—	—
R1/4 (040–060)	29	—	14	—	—	10.5	21	—	—
R3/8	36.5	6	—	17	20	11	55	—	—
Rc3/8	45.5	6	—	17	20	11	75	—	—
Rc1/2	56	8	—	22	25	14	140	150	—
Rc3/4	73	10	—	27	32	15	300	320	—
Rc1	94	14	—	34	40	17	585	625	—
Rc1*1/2	131	20	—	50	58	19	1,760	—	—
Rc2	168	24	—	60	70	23	2,980	—	—
Rc2*1/2	199	27	—	80	90	27	5,890	—	—
Rc3	220	30	—	90	105	30	9,400	—	—
Rc4	278	40	—	115	130	36	16,100	—	—

Figures in () after the pipe connection sizes indicate the spray capacity codes.

①Body ②Whirler

[Note] Appearance and dimensions may differ slightly depending on materials and nozzle codes.

BBXP series
Wide-angle Full Cone Spray Nozzles

Spray capacity code	Pipe conn. size		Spray angle (°)			Spray capacity (ℓ/min)										Mean droplet diameter (μm)	Free passage diameter (mm)
	R1/8	R1/4	0.05 MPa	0.2 MPa	0.5 MPa	0.03 MPa	0.05 MPa	0.1 MPa	0.15 MPa	0.2 MPa	0.35 MPa	0.5 MPa	0.7 MPa	1 MPa			
015	○	○	—	120	112	—	—	1.09	1.32	1.50	1.88	2.18	2.50	2.89	300	0.7	
020	○	○	110	120	112	—	1.06	1.46	1.75	2.00	2.51	2.91	3.34	3.86	340	0.9	
030	○	○	112	120	113	—	1.59	2.18	2.63	3.00	3.77	4.36	5.00	5.79	340	0.9	
040	○	○	110	120	112	—	2.12	2.91	3.51	4.00	5.03	5.81	6.67	7.72	350	1.4	
050	○	○	112	120	113	—	2.65	3.64	4.38	5.00	6.28	7.27	8.34	9.64	350	1.7	
060	○	○	114	120	114	2.51	3.18	4.37	5.26	6.00	7.54	8.72	10.0	11.6	430	1.7	

Spray capacity code	Pipe connection size											Spray angle (°)		Spray capacity (ℓ/min)										Mean drop. dia. (μm)	Free pass. dia. (mm)
	R 3/8	Rc 3/8	Rc 1/2	Rc 3/4	Rc 1	Rc 1 1/2	Rc 2	Rc 2 1/2	Rc 3	Rc 4	0.15 MPa	0.35 MPa	0.7 MPa	0.03 MPa	0.05 MPa	0.1 MPa	0.15 MPa	0.2 MPa	0.35 MPa	0.5 MPa	0.7 MPa	1 MPa			
10	○	○									123	120	111	3.34	4.21	5.79	6.98	7.96	10.0	11.6	13.3	15.3	340	2.0	
12	○	○									124	120	112	4.00	5.06	6.95	8.37	9.55	12.0	13.9	15.9	18.4	340	2.0	
14	○	○									124	120	112	4.67	5.90	8.10	9.77	11.1	14.0	16.2	18.6	21.5	340	2.4	
16	○	○									125	120	113	5.33	6.74	9.25	11.2	12.7	16.0	18.5	21.2	24.6	340	2.6	
18			○								123	120	111	6.00	7.58	10.4	12.6	14.3	18.0	20.8	23.9	27.6	420	2.8	
20			○								123	120	111	6.67	8.43	11.6	14.0	15.9	20.0	23.1	26.5	30.7	420	2.8	
23			○								124	120	112	7.67	9.69	13.3	16.0	18.3	23.0	26.6	30.5	35.3	420	2.8	
26			○								124	120	112	8.67	11.0	15.1	18.1	20.7	26.0	30.1	34.5	39.9	480	2.8	
30				○							123	120	111	10.0	12.6	17.4	20.9	23.9	30.0	34.7	39.8	46.0	580	3.8	
40				○							124	120	112	13.3	16.9	23.2	27.9	31.8	40.0	46.3	53.1	61.4	580	4.8	
50				○							125	120	113	16.7	21.0	29.0	34.9	39.8	50.0	57.8	66.3	76.7	580	4.8	
60					○						124	120	112	20.0	25.3	34.7	41.9	47.7	60.0	69.4	79.6	92.1	630	5.4	
80					○						125	120	113	26.7	33.7	46.3	55.8	63.7	80.0	92.5	106	123	630	6.0	
100						○					123	120	111	33.3	42.1	57.9	69.8	79.6	100	115	135	155	710	7.2	
150						○					124	120	112	50.0	63.2	86.9	105	120	150	175	200	230	710	8.5	
200							○				124	120	112	66.7	84.3	115	140	160	200	230	265	310	900	8.9	
300								○			125	120	113	100	125	175	210	240	300	350	400	460	900	10.2	
400									○		124	120	112	135	170	235	280	320	400	465	530	615	1,000	14.3	
500									○		125	120	113	170	210	290	350	400	500	580	665	770	1,000	14.3	
600										○	124	120	112	200	255	350	420	480	600	695	795	920	1,100	19.0	
700										○	125	120	113	235	295	405	490	550	700	810	930	1,070	1,100	19.0	
900											124	120	112	300	380	520	630	720	900	1,041	1,195	1,380	1,200	19.8	
1200										○	125	120	113	400	505	695	840	955	1,200	1,390	1,590	1,840	1,200	21.7	

Conversion of unit [Pressure] 0.1 MPa ≈ 14.50 psi [Flow rate] 1 ℓ (liter) ≈ 0.26 US gal.
10 psi ≈ 0.07 MPa 1 US gal. ≈ 3.79 ℓ (liter)

How to order

Please inquire or order for a specific nozzle using this coding system.

<Example> 1/8M BBXP 015 S303

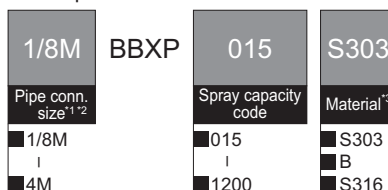

*1) "M" indicates male thread ("R" of the ISO standard) and "F" indicates female thread ("Rc" of the ISO standard).

To order, please specify the pipe connection size by replacing respectively "R" and "Rc" by "M" and "F" as in the above chart.

*2) When spray capacity code is 015–030, pipe connection size for R1/4 is indicated as "1/4x1/8M".

*3) See "MATERIALS" information on page 59 for standard materials by each size.

SSXP series Square Full Cone Spray Nozzles

Steel making process

● Cooling steel in CCM

Rolling mill process

● Cooling plates



FEATURES

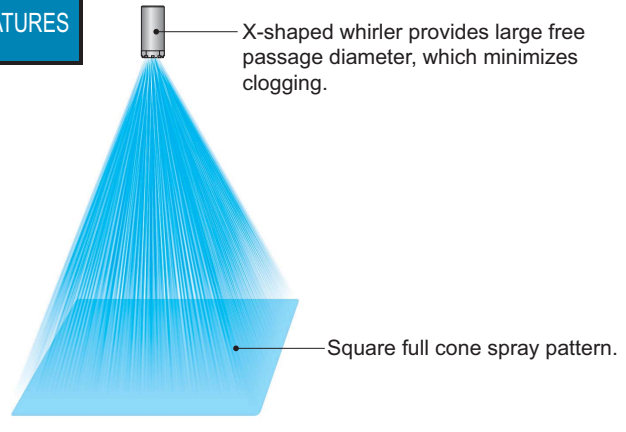

SSXP series

MATERIALS

- Sizes R1/8, R1/4: S303
- Sizes Rc3/8–Rc1: S303 or B (brass)

OPTIONAL MATERIAL: S316L (SCS16)

Pipe conn. size	Dimensions (mm)							Mass (g)	
	L ₁	L ₂	H	W	øD ₁	øD ₂	N	S303	B
R1/8	21	—	12	—	11.5	—	7	11.5	12
R1/4	29	—	14	—	13.5	—	10.5	20	21.5
R3/8	45.5	6	—	17	—	20	11	70	74
Rc1/2	56	8	—	22	—	25	14	150	160
Rc3/4	73	10	—	27	—	32	15	300	320
Rc1	94	14	—	34	—	40	17	575	620

[Note] Appearance and dimensions may differ slightly depending on materials and nozzle codes.

R1/8, R1/4

Rc3/8 and over

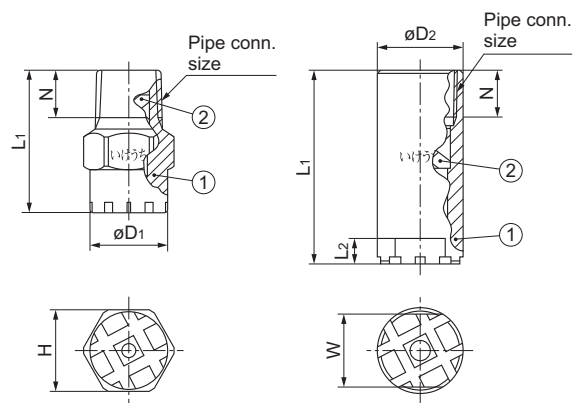

Spray capacity code	Pipe connection size						Spray angle (°)			Spray capacity (ℓ/min)							Mean drop. dia. (μm)	Free pass. dia. (mm)		
	R1/8	R1/4	Rc3/8	Rc1/2	Rc3/4	Rc1	0.05 MPa	0.2 MPa	0.5 MPa	0.03 MPa	0.05 MPa	0.1 MPa	0.15 MPa	0.2 MPa	0.3 MPa	0.5 MPa			0.7 MPa	1 MPa
020	○						86	90	81	—	1.06	1.46	1.75	2.00	2.36	2.91	3.34	3.86	330	0.9
030	○						86	90	81	—	1.59	2.18	2.63	3.00	3.54	4.36	5.00	5.79	380	1.2
040		○					90	95	85	—	2.12	2.91	3.51	4.00	4.72	5.81	6.67	7.72	360	1.3
050		○					91	95	86	—	2.65	3.64	4.38	5.00	5.90	7.27	8.34	9.64	—	1.7
060		○					91	95	86	2.51	3.18	4.37	5.26	6.00	7.08	8.72	10.0	11.6	490	1.7
070			○				94	100	89	2.93	3.71	5.09	6.14	7.00	8.26	10.2	11.7	13.5	—	2.0
080			○				95	100	90	3.35	4.24	5.82	7.01	8.00	9.44	11.6	13.3	15.4	—	2.0
10			○				96	100	91	4.19	5.29	7.28	8.77	10.0	11.8	14.5	16.7	19.3	—	2.6
12			○				97	100	92	5.03	6.35	8.73	10.5	12.0	14.2	17.4	20.0	23.1	630	2.6
16				○			95	100	90	6.70	8.47	11.6	14.0	16.0	18.9	23.3	26.7	30.9	—	2.8
20				○			96	100	91	8.36	10.6	14.6	17.5	20.0	23.6	29.1	33.4	38.6	710	3.5
30					○		96	100	91	12.6	15.9	21.8	26.3	30.0	35.4	43.6	50.0	57.9	—	3.8
40					○		97	100	92	16.8	21.2	29.1	35.1	40.0	47.2	58.1	66.7	77.2	—	4.8
50						○	95	100	90	20.9	26.5	36.4	43.8	50.0	59.0	72.7	83.4	96.4	750	5.4
60						○	96	100	91	25.1	31.8	43.7	52.6	60.0	70.8	87.2	100	115	—	5.4
80						○	97	100	92	33.5	42.4	58.2	70.1	80.0	94.4	115	135	155	1,000	6.0

Conversion of unit [Pressure] 0.1 MPa ≈ 14.50 psi [Flow rate] 1 ℓ (liter) ≈ 0.26 US gal.
10 psi ≈ 0.07 MPa 1 US gal. ≈ 3.79 ℓ (liter)

How to order

Please inquire or order for a specific nozzle using this coding system.

**"M" indicates male thread (R) and "F" indicates female thread (Rc).

To order, please specify the pipe connection size by replacing respectively "R" and "Rc" by "M" and "F" as in the above chart.

<Example> 1/8M SSXP 020 S303

1/8M	SSXP	020	S303
Pipe conn. size*		Spray capacity code	Material
1/8M		020	S303
1M		80	B

TJJX series Flange Type Full Cone Spray Nozzles

Raw material process

Gas absorption/gas cleaning in flue gas desulfurization

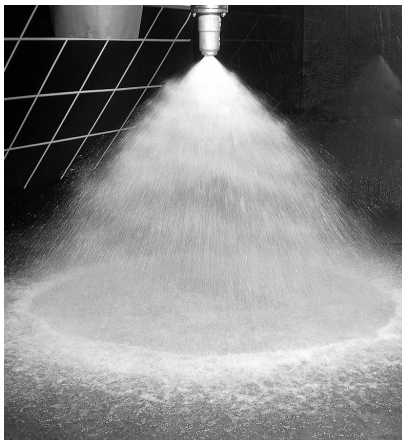

FEATURES

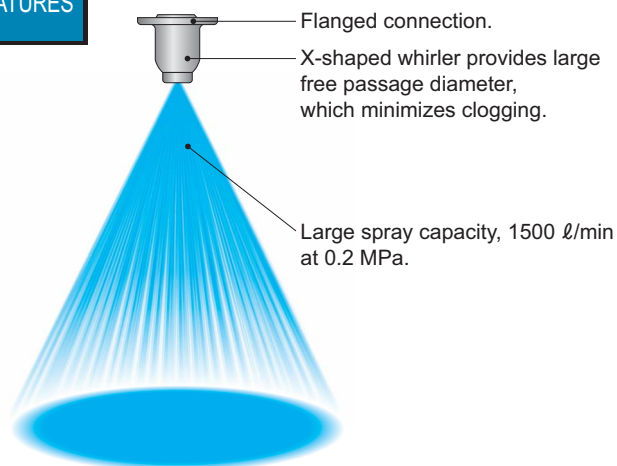

TJJX series

MATERIALS

- ① Body: S304, S316, SCS13, or SCS14
- ② Whirler: SCS13 or SCS14
- ③ Lock bolt: S316

OPTIONAL MATERIAL: S316L, SCS16

Flange size	Dimensions (mm)					Flange bolt holes (JIS 10K)		Mass (kg)
	L	øD1	øD2	øD3	t	Number of bolts	Diameter (mm)	
4T	171	210	175	117	18	8	19	9.3
5T	211	250	210	143	20	8	23	11.4
6T	253	280	240	169	22	8	23	22.7

[Note] Appearance and dimensions may differ slightly depending on materials and nozzle codes.

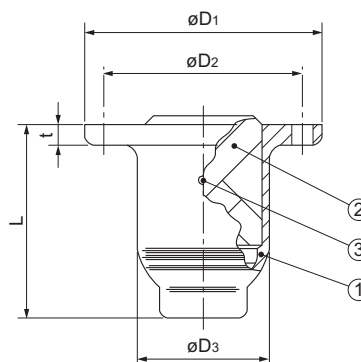

①Body ②Whirler ③Lock bolt

Spray capacity code	Flange size			Spray angle (°)			Spray capacity (l/min)						Mean droplet diameter (µm)	Free passage diameter (mm)	
	4T	5T	6T	0.05 MPa	0.2 MPa	0.5 MPa	0.03 MPa	0.05 MPa	0.1 MPa	0.15 MPa	0.2 MPa	0.3 MPa			0.5 MPa
1500	○			90	90	75	628	794	1,091	1,315	1,500	1,770	2,180	1,850	29
2000	○			100	100	85	838	1,059	1,455	1,753	2,000	2,360	2,907		29
2500		○		90	90	75	1,047	1,324	1,819	2,191	2,500	2,950	3,634	2,500	36
3000		○		100	100	85	1,257	1,588	2,183	2,629	3,000	3,540	4,361		36
3500			○	90	90	75	1,466	1,853	2,547	3,067	3,500	4,130	5,087	2,650	44
4000			○	95	95	80	1,675	2,118	2,911	3,505	4,000	4,720	5,814		44

TJJX series nozzle with larger spray flow and larger flange is available upon request. For spraying slurry, TJJX-SiC series nozzles made of highly wear-resistant SiC (silicon nitride bonded silicon carbide) are available.

Conversion of unit [Pressure] 0.1 MPa ≈ 14.50 psi 10 psi ≈ 0.07 MPa [Flow rate] 1 l (liter) ≈ 0.26 US gal. 1 US gal. ≈ 3.79 l (liter)

How to order

Please inquire or order for a specific nozzle using this coding system.

<Example> 4TJJX 1500 S304

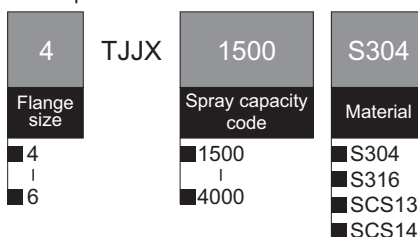

7JJXP series 7-head Full Cone Spray Nozzles

Iron making process

● Gas cooling

Rolling mill process

● Cleaning inside of tank

FEATURES

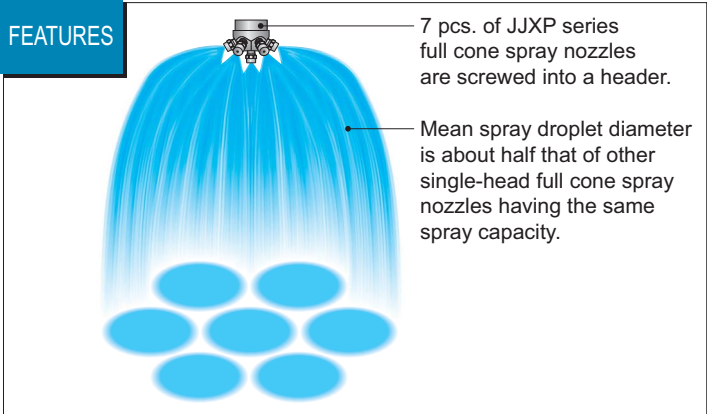

7JJXP series

MATERIALS S303 or B (Brass)

OPTIONAL MATERIALS: S316

Pipe conn. size	Dimensions (mm)					Mass (g)	
	L ₁	L ₂	L ₃	W	N	S303	B
Rc3/4	71	55	13	40	15	380	400
Rc1 (280)	89	67.5	17	46	17	620	660
Rc1 (490, 840)	103	75	20	55	17	1,080	1,140
Rc1*1/2	128	92.5	20	70	19	1,860	1,970
Rc2	166	121.5	27	85	23	3,650	3,870

Figures in () after the pipe connection sizes indicate the spray capacity codes.

[Note] Appearance and dimensions may differ slightly depending on materials and nozzle codes.

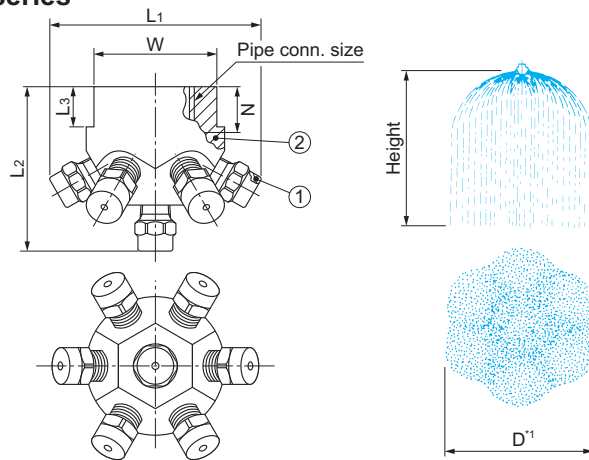

①JJXP series full cone spray nozzle ②Header

*1) Please refer to the chart below for spray dimension D.

Spray capacity code	Pipe conn. size				Spray angle (°)			Spray dimension D (m)* at each spray height (at 0.2 MPa)					Spray capacity (ℓ/min)								Mean drop. dia. (μm)	Free pass. dia. (mm)			
	Rc 3/4	Rc 1	Rc 1 1/2	Rc 2	0.05 MPa	0.2 MPa	0.5 MPa	1 m	1.5 m	2 m	2.5 m	3 m	3.5 m	0.05 MPa	0.1 MPa	0.15 MPa	0.2 MPa	0.3 MPa	0.5 MPa	0.7 MPa			1 MPa	1.5 MPa	2 MPa
	70	○				170	175	165	1.9	2.4	2.8	3.0	3.1	3.1	—	5.11	6.16	7.00	8.26	10.2			11.7	13.5	15.9
140	○				180	185	175	2.7	3.3	3.8	4.2	4.5	4.7	—	10.2	12.3	14.0	16.5	20.4	23.4	27.0	31.9	35.8	—	1.4
280		○			180	185	175	3.4	3.9	4.4	4.8	5.2	5.4	14.8	20.4	24.6	28.0	33.0	40.7	46.7	54.0	63.7	71.7	380	1.7
490		○			180	185	180	4.3	4.8	5.4	5.8	6.2	6.4	26.0	35.6	43.0	49.0	57.8	71.4	81.9	94.5	112	125	480	1.9
840		○			200	205	200	5.2	5.8	6.3	6.8	7.2	7.5	44.5	61.1	73.5	84.0	99.4	122	140	162	191	215	660	2.6
1120			○		190	195	180	5.6	6.3	6.9	7.4	7.8	8.1	59.3	81.2	98.0	112	132	163	187	216	255	287	—	3.5
1400			○		200	205	190	6.0	6.7	7.3	7.8	8.3	8.6	74.2	102	123	140	165	204	234	270	319	358	740	3.5
1820				○	195	200	185	6.2	6.9	7.5	8.0	8.5	8.8	96.6	132	160	182	215	265	304	351	414	466	—	4.7
2450				○	205	210	195	6.4	7.1	7.7	8.2	8.7	9.0	130	179	215	245	289	356	409	473	558	627	—	4.7
3150				○	210	215	200	6.6	7.3	7.9	8.4	8.9	9.2	167	229	277	315	372	458	525	608	717	806	950	4.7

[Note] 7JJXP series nozzles are guaranteed only for spray capacity under the standard pressure.

Conversion of unit [Pressure] 0.1 MPa ≈ 14.50 psi [Flow rate] 1 ℓ (liter) ≈ 0.26 US gal.
10 psi ≈ 0.07 MPa 1 US gal. ≈ 3.79 ℓ (liter)

Sister product

13JJXP series 13-head Full Cone Spray Nozzles

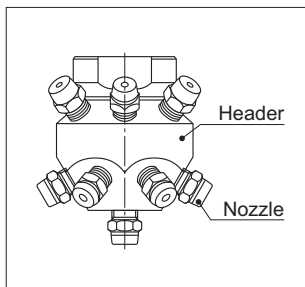

13 full cone spray nozzles are screwed into a very compact header. Spraying water 360° in all directions.

How to order

Please inquire or order for a specific nozzle using this coding system.

<Example> 3/4F 7JJXP 70 S303

3/4F	7JJXP	70	S303
Pipe conn. size*2		Spray capacity code	Material
3/4F		70	S303
1		3150	B
2F			

*2) "M" indicates male thread (R) and "F" indicates female thread (Rc).

To order, please specify the pipe connection size by replacing respectively "R" and "Rc" by "M" and "F" as in the above chart.

SPB series SPILLBACK Nozzle with Variable Flow

Raw material / pig iron making process

- Gas cooling in flue gas desulfurization
- Gas cooling in blast furnace (dry dust catcher)
- Moisture conditioning of supply air to blast furnace (water spraying to hot blast stove)

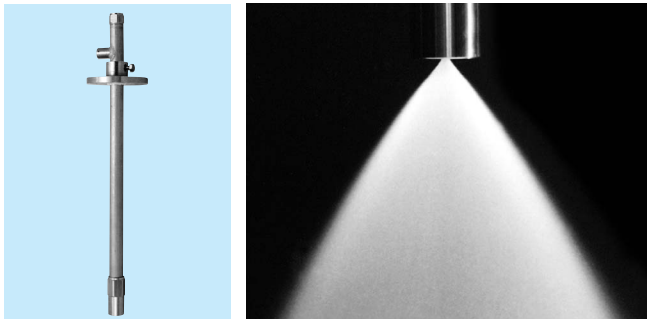

FEATURES

Spray capacity can be controlled by opening/closing the return flow valve while supply pressure is kept constant. Featuring minimal variation in spray droplet size with a large turndown ratio of spray capacity (1:10), SPB series nozzles are ideal for gas cooling where the inlet gas temperature and gas flow rate varies.

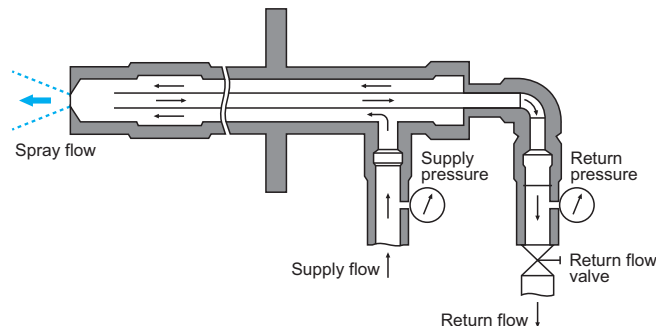

Fine atomization with no large droplets

The variation in spray droplet sizes is minimized despite the modulation of spray flow rate, SPILLBACK nozzle is suitable for evaporative cooling in cooling towers where the inlet gas temperature varies.

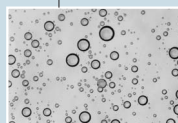
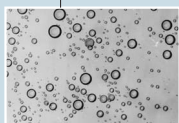
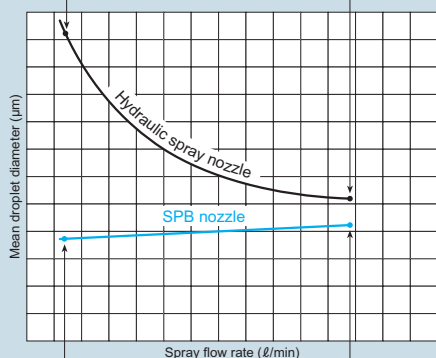
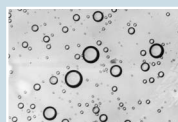
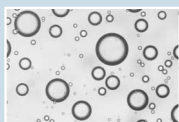

Turndown ratio is 1:10

Spray capacity is maximized by fully closing the return flow valve and minimized by fully opening the return flow valve. The turndown ratio of spray capacity is 1:10.

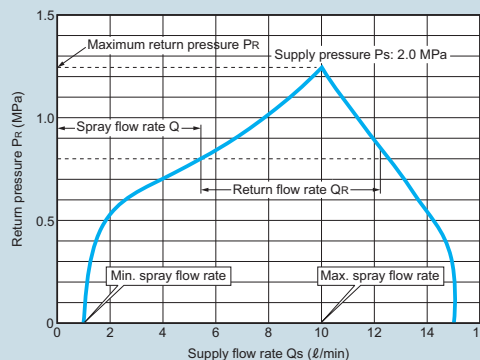

Use in flue gas cooling tower

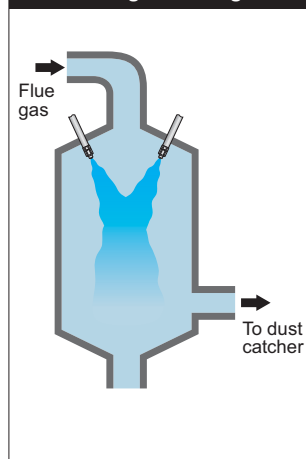

SPB nozzles used in air inlets of blast furnace

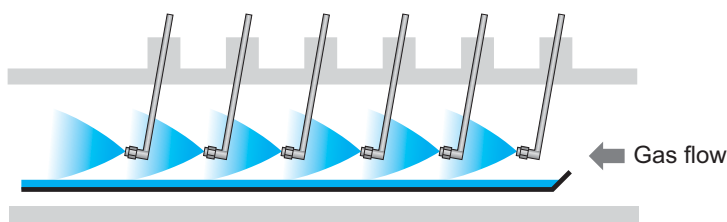

Affiliated SPILLBACK Nozzles for finer atomization

Sister products

SPB series

4-orifice and multiple-head SPILLBACK Nozzles



Nozzles mounted with multiple single-orifice nozzle tips for excellent atomizing performance at the same spray flow.

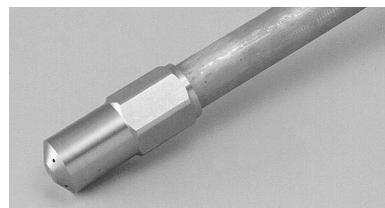

4-orifice SPILLBACK Nozzle

The mean droplet diameter is 12% smaller compared to the standard SPB series nozzle.

Please contact our local sales office for details.

**KKK
series**

Hollow Cone Spray Nozzles w/ Variable Spray Angle & Spray Capacity

Iron making process

● Cooling slag

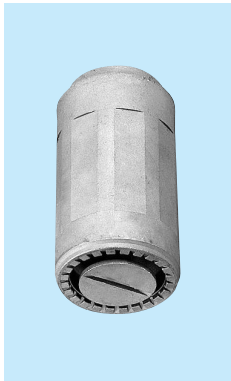

FEATURES



Spray angle and spray capacity can be changed as desired by turning the adjustment cap.

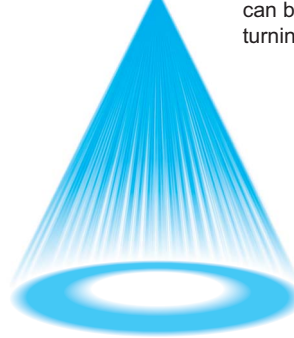

KKK series

1F KKK 2*Ø/240-320SCS13

MATERIAL SCS13

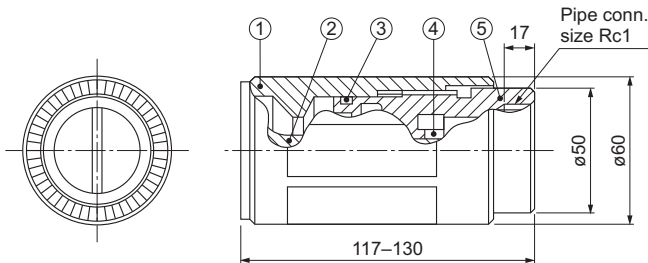

①Body ②Cap ③O-ring ④Lock nut ⑤Body

KKK nozzles used in slag cooling

Cooling zone can be changed by altering spray angle and spray capacity, which allows effective slab cooling.

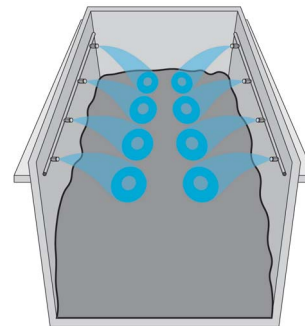

Slag pit

● Available KKK series

Series	Pipe connection size	Pressure: 0.2 MPa	
		Spray angle	Spray capacity (ℓ/min)
1FKKK 2*Ø/240-320SCS13	Rc1	105°	240-320
1*1/4FKKK 2*Ø/300-400SCS13	Rc1*1/4	105°	300-400

Conversion of unit [Pressure] 0.1 MPa ≈ 14.50 psi [Flow rate] 1 ℓ (liter) ≈ 0.26 US gal.
10 psi ≈ 0.07 MPa 1 US gal. ≈ 3.79 ℓ (liter)

How to order

Please inquire or order using these product codes.

1F KKK 2*Ø/240-320 SCS13

OR

1*1/4F KKK 2*Ø/300-400 SCS13

Technical data

Change in spray angle and spray capacity by turning cap

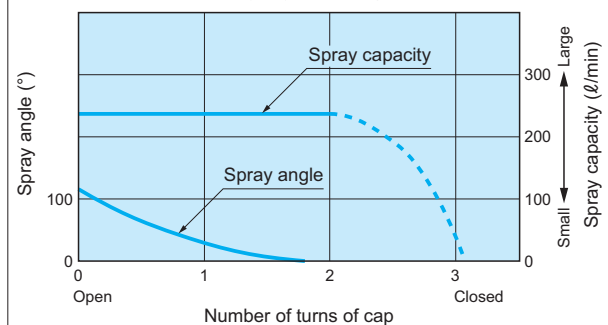

**3OV
series**

3-Head Off-center Flat Spray Nozzles

Various process

- Water spraying
- Dust suppression
- Cooling

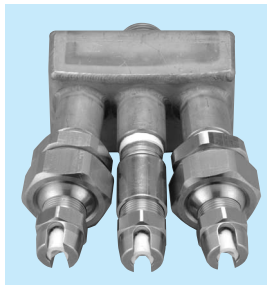

FEATURES

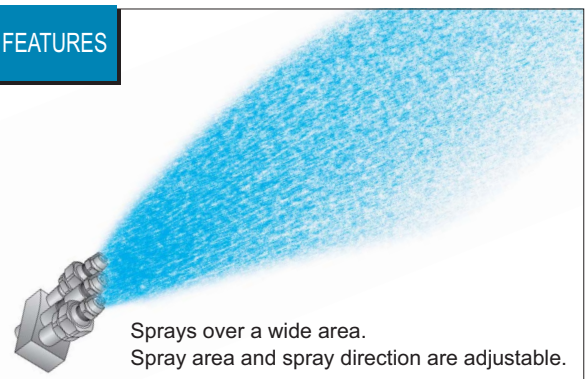

Sprays over a wide area.
Spray area and spray direction are adjustable.

Please contact our local sales office for details.

**CMP-Sa
series**

Solid Stream Jet with Wear-resistant Sapphire Orifice

Raw material process

- Cleaning electric furnace covers of coke ovens

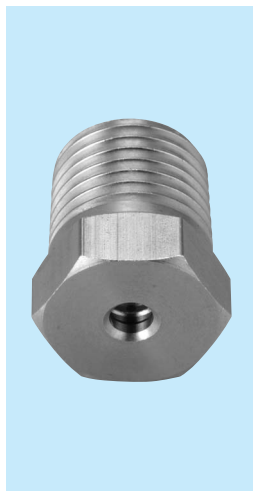

FEATURES

Highly wear-resistant sapphire orifice inserted.



CMP-Sa series

MATERIAL S303

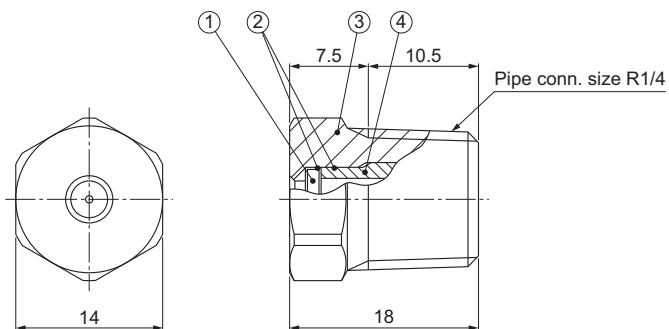

[Note] Appearance and dimensions may differ slightly depending on materials and nozzle codes.

①Sapphire orifice ②Adhesive: Araldite®H ③Body ④Sleeve

Orifice diameter code	Spray capacity (ℓ/min)					
	5.0 MPa	10 MPa	20 MPa	30 MPa	50 MPa	70 MPa
ø0.4	0.52	0.72	1.01	1.22	1.56	1.83
ø0.5	0.76	1.05	1.47	1.78	2.28	2.67
ø0.6	1.10	1.54	2.14	2.60	3.32	3.89
ø0.7	1.49	2.08	2.89	3.51	4.49	5.27
ø0.8	1.94	2.71	3.77	4.58	5.85	6.87
ø0.9	2.35	3.28	4.57	5.55	7.09	8.32
ø1.0	2.89	4.03	5.62	6.82	8.71	10.2

The above nozzles are manufactured for specific orifice diameters, therefore spray capacity is not guaranteed.

Conversion of unit [Pressure] 0.1 MPa ≈ 14.50 psi [Flow rate] 1 ℓ (liter) ≈ 0.26 US gal.
10 psi ≈ 0.07 MPa 1 US gal. ≈ 3.79 ℓ (liter)

How to order

Please inquire or order for a specific nozzle using this coding system.

<Example> 1/4×1/8M CMP ø0.4 Sa-S303 (H14-18, t=2, w/ adhesive sleeve, w/ high temperature adhesive)

1/4x1/8M CMP ø0.4 Sa-S303 (H14-18, t=2, w/ adhesive sleeve, w/ high temperature adhesive)

Orifice diameter code

- ø0.4
-
- ø1.0

TAIFUJet® series Air Booster Nozzles

Various process

- Air cooling
- Blowing off drying
- Stripping
- Cleaning
- Blowing off dust
- Air blow transport

FEATURES

Flat type

Noise level is reduced by 10 dB compared to a conventional one-hole air nozzle with the same air volume.

Uniform air flow resulting from the unique design.

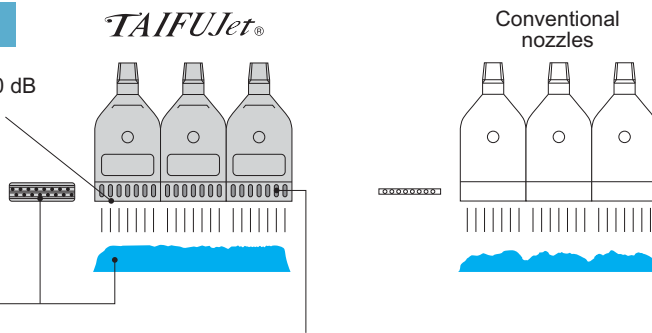

The special configuration takes in surrounding air and boosts powerful air flow.

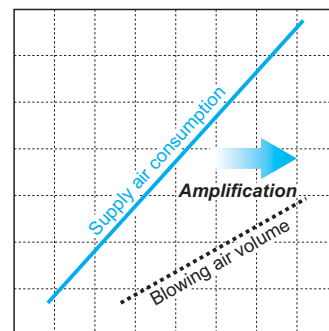

Long flat type

Space-saving design

Long flat type designed for blowing air over greater widths. Width type, 100 mm–1400 mm, are available.

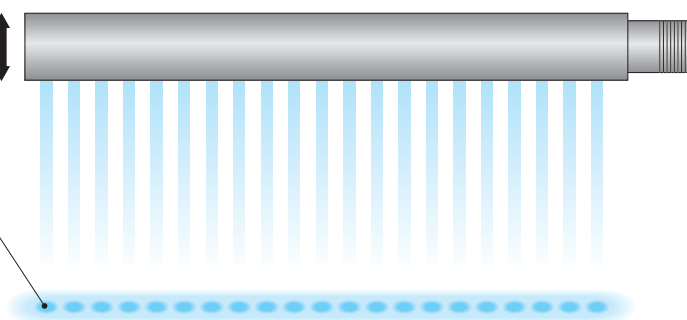

Round type

Noise level reduced by more than 10 dB compared to a conventional one-hole air nozzle with the same air volume.

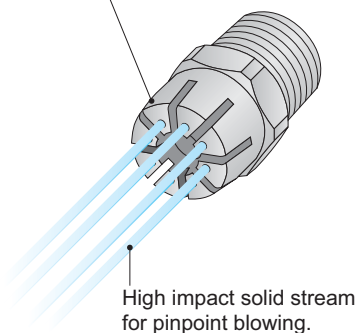

Noise level comparison

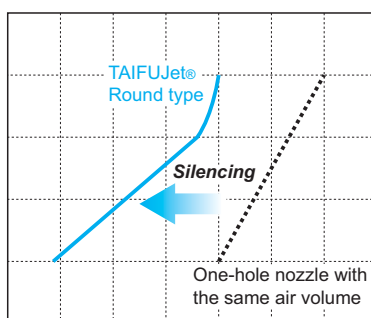

Cluster header round type

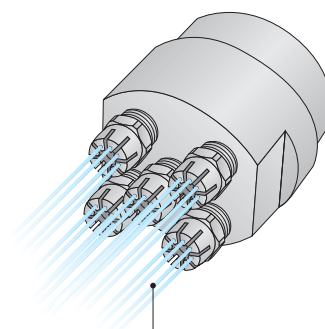

Powerful air flow.

TAIFUJet® Usage examples

Blowing off dust from steel plates

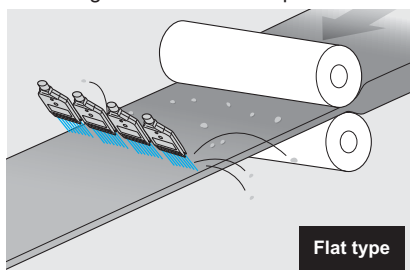

Edge wiper for steel surface treatment (Blowing off liquid)

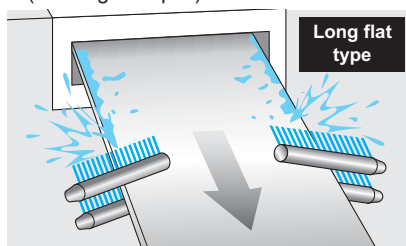

Blowing off water from shaped steel

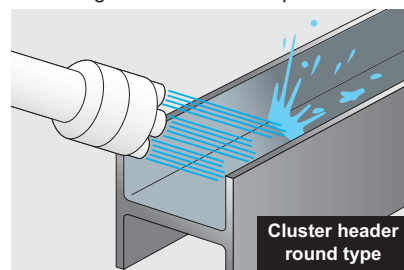

TAIFUJet® Air Nozzles Lineup

FOR COMPRESSORS

FLAT TYPE

PLASTIC

Affordable, 42 mm wide standard flat air nozzle.



- Orifice diameter: $\varnothing 1.0$ mm
- Width: 42 mm
- Material: PPS
- Pipe conn. size: R1/4

121 mm wide broad type air nozzle.



- Orifice diameter: $\varnothing 1.0$ mm
- Width: 121 mm
- Material: PPS
- Pipe connection size: R3/8

24 mm wide, 30 mm long, ultra-compact air nozzle.



- Orifice diameter: $\varnothing 1.0$ mm
- Width: 24 mm
- Material: PPS
- Pipe connection size: R1/8

ROUND TYPE



Affordable, standard round type air nozzle for high-impact, pinpoint blowing.

- Orifice diameter: $\varnothing 1.0$ mm
- Material: PP

METAL

42 mm wide, stainless steel air nozzle. Available in three orifice diameters.

- Orifice diameter: $\varnothing 0.8$, $\varnothing 1.0$, or $\varnothing 1.2$ mm
- Width: 42 mm
- Material: Stainless steel
- Pipe connection size: R1/4



Compact and wider flat air nozzle.

- Orifice diameter: $\varnothing 1.2$ mm
- Width: 50 mm
- Material: Stainless steel
- Pipe connection size: R1/4



Long flat type space-saving design. Available from 100 mm to 1400 mm in length.



- Orifice diameter: $\varnothing 1.0$ mm
- Width: 100 mm–1,400 mm
- Material: Stainless steel
- Pipe conn. size: R1/2–R1*1/2

Stainless steel air nozzle for pinpoint blowing. Available in two sizes (R1/8 and R1/4) and five orifice diameters.



- Orifice diameter: $\varnothing 0.8$ – $\varnothing 1.6$ mm
- Material: Stainless steel
- Pipe conn. size: R1/8, R1/4

Multiple header type for applications needing stronger surface air flow.



Header with a cluster of 5 round-type stainless steel air nozzles.

Triple cluster header includes 3 clusters each equipped with 7 round-type stainless steel air nozzles.

FOR BLOWERS

FLAT TYPE

PLASTIC

42 mm wide standard flat air nozzle.

- Orifice diameter: $\varnothing 3.0$ mm
- Width: 42 mm
- Material: ABS
- Pipe conn. size: R1/2



Plastic, long flat type. Space-saving design.

- Orifice diameter: $\varnothing 3.0$ mm
- Length: Please specify
- Material: PPS (nozzle tip), HTPVC (header)



METAL

42 mm wide flat air nozzle made of aluminum.

- Orifice diameter: $\varnothing 3.0$ mm
- Width: 42 mm
- Material: Aluminum
- Pipe conn. size: R1/2



Aluminum, long flat type. Space-saving design.

- Orifice diameter: $\varnothing 3.0$ mm
- Length: Please specify
- Material: Aluminum



ROUND TYPE



Blower air nozzle for high-impact, pinpoint blowing.

- Orifice diameter: $\varnothing 3.0$ mm
- Material: ABS

Aluminum nozzle for high-impact, pinpoint air blowing.

- Orifice diameter: $\varnothing 3.0$ mm
- Material: Aluminum



SLNH-H/SLNHA-H series Slit Nozzles (Water/Air Curtain)

Various process

- Water cooling
- Cleaning
- Air blowing

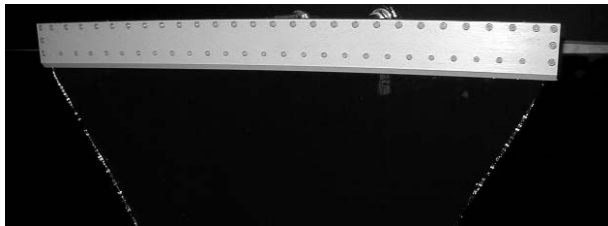

FEATURES

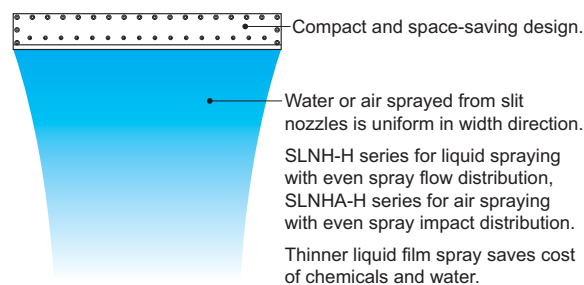

SLNH-H/SLNHA-H series

MATERIAL S304 or PVC

Series	Slit length ℓ (mm)	Slit opening t (mm)	Effective liquid film width (mm) at 10 mm height	Number of inlets	Thread size		Total length (mm) L ¹	Mass (kg)	
					Fluid inlet	Fixing		S304	PVC
SLNH-H (Liquid spraying)	460	0.1	410	2	Rc3/8	M5	490	4.3	1.3
	600		550				630	5.5	1.6
	700		650				730	6.4	1.9
	780		730				810	7.1	2.1
	1,200	0.3	1,150	3	Rc1/2	M5	1,230	11.0	3.1
	460		410				490	4.3	1.3
	600		550				630	5.5	1.6
	700		650				730	6.4	1.9
780	730	810	7.1	2.1					
1,200	1,150	1,230	11.0	3.1					
SLNHA-H (Air spraying)	530	0.1	—	2	Rc3/8	M5	560	5.0	1.5
	700		730				6.5	1.9	
	810		840				7.5	2.2	
	900		930				8.0	2.5	
	1,400		1,430				12.0	4.0	

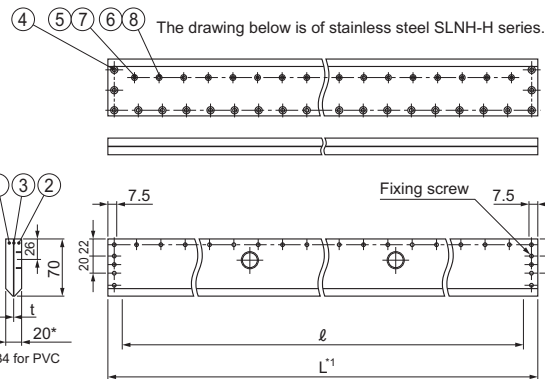

Depth of the fixing screw is 8 mm for S304, 10 mm for PVC.

*1) Available total length (L): Min. 250 mm–Max. 3,950 mm for S304, Min. 250 mm–Max. 2,950 mm for PVC

[Note] Appearance and dimensions may differ slightly depending on materials and nozzle codes.

Series	Slit length (mm)	Slit opening (mm)	Spray capacity (ℓ/min)							
			0.01 MPa	0.02 MPa	0.03 MPa	0.04 MPa	0.05 MPa	0.06 MPa	0.07 MPa	0.08 MPa
SLNH-H (Liquid spraying)	460	0.1	7.2	10.7	13.4	15.7	17.8	19.7	21.4	23.1
	600		9.4	13.9	17.4	20.5	23.2	25.7	27.9	30.1
	700		11.0	16.2	20.3	23.9	27.0	29.9	32.6	35.1
	780		12.3	18.1	22.7	26.6	30.1	33.3	36.3	39.1
	1200	18.9	27.8	34.9	40.9	46.4	51.3	55.9	60.2	
	460	0.3	21.7	32.0	40.1	47.1	53.3	59.0	64.3	69.2
	600		28.3	41.7	52.3	61.4	69.5	77.0	83.8	90.3
	700		33.0	48.7	61.0	71.7	81.1	89.8	97.8	105
780	36.8		54.2	68.0	79.8	90.4	100	109	117	
1200	56.6	83.4	105	123	139	154	168	181		
SLNHA-H (Air spraying)	530	0.1	209	355	472	570	657	736	810	880
	700		276	469	623	753	868	972	1,070	1,160
	810		319	543	721	871	1,000	1,130	1,240	1,350
	900		355	603	802	968	1,120	1,250	1,380	1,490
	1400		552	938	1,250	1,510	1,740	1,940	2,140	2,330

• The above spray capacity indicates liquid flow rate for SLNH-H series, and air flow rate for SLNHA-H series.

• Measure for air flow rate is ℓ/min at normal conditions (0°C, 1atm).

[Note] The above spray capacities are for reference only and subject to design changes.

Conversion of unit [Pressure] 0.1 MPa ≈ 14.50 psi
 10 psi ≈ 0.07 MPa
 [Flow rate] 1 ℓ (liter) ≈ 0.26 US gal.
 1 US gal. ≈ 3.79 ℓ (liter)

How to order

Please inquire or order for a specific nozzle using this coding system.

Liquid spraying SLNH-H series

<Example> 2-3/8F SLNH-H 460x0.1 PVC

2-3/8F	SLNH-H	460	x	0.1	PVC
Number of inlets – Thread size ²		Slit length		Slit opening	Material
■ 2-3/8F		■ 460		■ 0.1	■ S304
■ 2-1/2F		■ 600		■ 0.3	■ PVC
■ 3-1/2F		■ 700			
■ 4-1/2F		■ 780			
■ 5-1/2F		■ 1200			

Air spraying SLNHA-H series

<Example> 2-3/8F SLNHA-H 530x0.1 PVC

2-3/8F	SLNHA-H	530	x	0.1	PVC
Number of inlets – Thread size ²		Slit length		Slit opening	Material
■ 2-3/8F		■ 530			■ S304
■ 2-1/2F		■ 700			■ PVC
■ 3-1/2F		■ 810			
		■ 900			
		■ 1400			

*2) "M" indicates male thread ("R" of the ISO standard) and "F" indicates female thread ("Rc" of the ISO standard).

To order, please specify the pipe connection size by replacing respectively "R" and "Rc" by "M" and "F" as in the above chart.

SLNB series Slit Nozzles Utilizing Blower Air

Various process

- Blowing off liquid (Air Knife)
- Air blowing
- Cooling

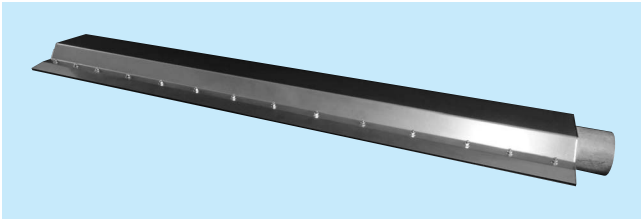

FEATURES

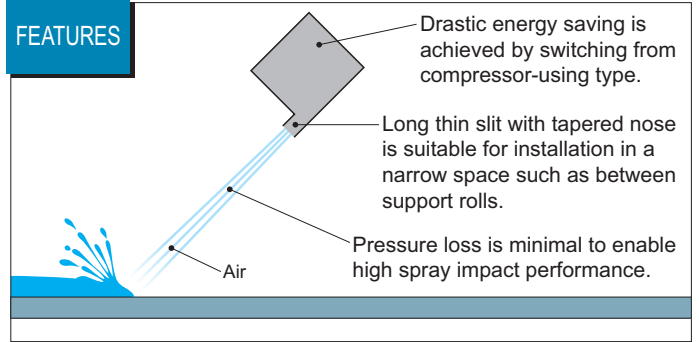

SLNB series

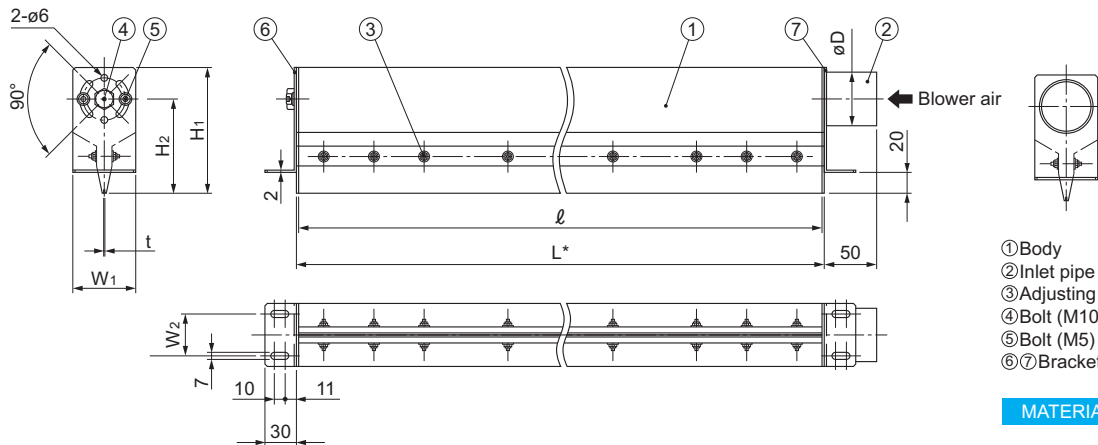

Air inlet type	Slit length ℓ (mm)	Slit opening t (mm)	Outer dimensions (mm)					Mass (kg)	
			L*	H ₁	H ₂	W ₁	W ₂		ϕ D
D38	400	0.5	404	105	80	50	30	38.0	1.9
	600		604						2.7
	800		804						3.5
	1,000		1,004						4.3
D50	1,200		1,204	120	90	60	40	50.8	5.9
D38	400	1.0	404	105	80	50	30	38.0	1.9
	600		604						3.2
	800		804						4.1
D65	1,000		1,004	140	102.5	75	50	63.5	6.2
	1,200	1,204	7.4						

*Minimum available length of L is 250 mm, maximum length is 1,950 mm.
 [Note] Appearance and dimensions may differ slightly depending on materials and nozzle codes.

Slit length (mm)	Slit opening (mm)	Blowing air volume (air consumption) [m ³ /min, Normal]					
		5 kPa	10 kPa	15 kPa	20 kPa	25 kPa	30 kPa
400	0.5	0.97	1.60	2.01	2.58	3.01	3.40
600		1.45	2.39	3.18	3.87	4.51	5.10
800		1.94	3.19	4.24	5.17	6.01	6.80
1000		2.42	3.99	5.30	6.46	7.52	8.50
1200		2.91	4.79	6.36	7.75	9.02	10.20
400	1.0	1.91	2.81	3.52	4.13	4.67	5.16
600		2.87	4.22	5.28	6.19	7.00	7.74
800		3.82	5.62	7.04	8.23	9.34	10.33
1000		4.78	7.03	8.80	10.32	11.67	12.91
1200		5.73	8.43	10.56	12.39	14.01	15.49

How to order

Please inquire or order for a specific nozzle using this coding system.

<Example> D65 SLNB 1200x1.0 S304-S-A



LLYOH series Blower LYOHM Header

Surface finish

- Cooling steel plate in each process of CGL, CAPL, EGL, CCL

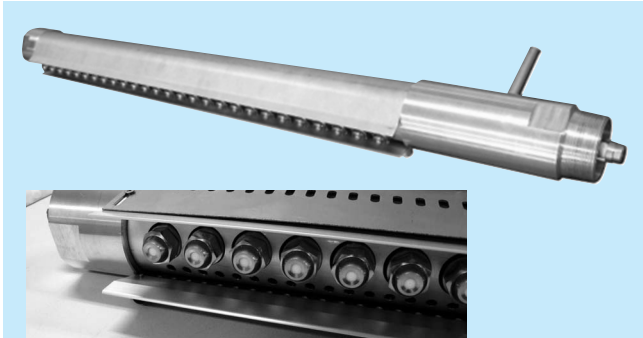

Equips LYOHM nozzles producing Semi-Dry Fog® with droplet diameters of 10–30 µm

FEATURES

Slow cooling unit. Cooling capacity exceeds cooling by air alone.

High-pressure water (6 MPa)

Blower air

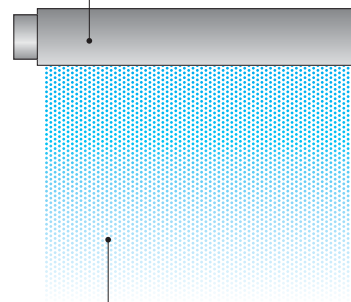

Blower air gives directional flow of the 10–30µm Semi-Dry Fog® while supporting a relatively smooth flow rate distribution.

● Spray capacity and blower air consumption

Liquid pressure (MPa)	Spray capacity (ℓ/min)	Blower air pressure (kPa)	Blower air consumption (m³/min)
6	28.3	0	0
		1	2.4
		3	4.46
		5	5.72
		7	6.69

Performance data of Blower LYOHM header with 27 pcs. of LYOHM nozzles, spray length 700 mm.

How to order

Please contact our local sales office for details.

● Relationship between blower pressure and droplet speed

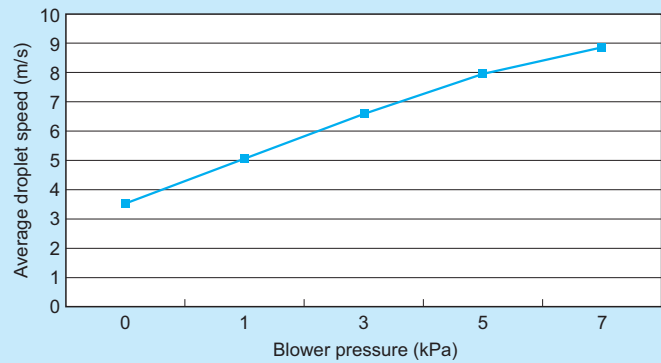

At distances under 150 mm, droplet speed is roughly proportional to blower pressure.

PSN series Pneumatic Slit Nozzles



FEATURES

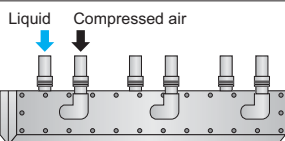

High impact available at short spray distance.

Even spray distribution across the entire width ensures uniform cleaning/cooling without gaps, leaving no spot unwashed/uncooled.

Pneumatic Slit Nozzles PSN series Spray impact and Spray flow distribution data

Spray conditions

Product: PSN650x0.15
Spray distance: 10 mm

- Air consumption: 2,340 ℓ/min, Normal
- Spray capacity: 15.6 ℓ/min
- Air-water ratio: 150
- Compressed air pressure: 0.27 MPa
- Water pressure: 0.25 MPa

Spray impact distribution

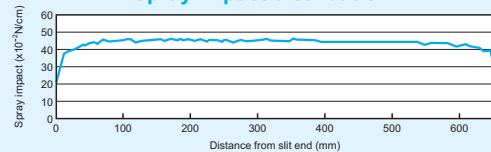

Max. value 46.14 Min. value 42.14 Median value 43.64 Deviation from median +/-3.4 %

Spray flow distribution

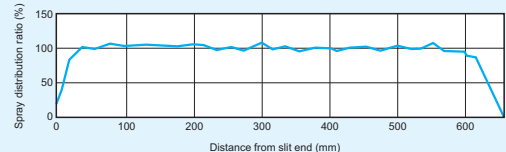

Deviation from median +/-6.1 %

How to order

Please contact our local sales office for details.

UT series Universal Ball Joints

Metal



Photo is UT Ball Joint with a spray nozzle.

FEATURES

- Accurate nozzle alignment is possible after connected to pipe.
- Adjust spray direction over a range of 50° as desired.

⚠ Cautions for use

Maximum pressure:
15 MPa for UT-S303
4 MPa for UT-B (Brass)

Do not use under conditions where sudden change of water pressure occurs.

Plastic



Photo is UT Ball Joint with a spray nozzle.

FEATURES

- Adjustable spray direction while spraying up to 0.3 MPa.
- No O-ring. Easy installation by hand without tools.
- Lightweight, only half of metal joint.
- Low price due to injection molding.

⚠ Cautions for use

Maximum pressure is 1 MPa.
Use at normal temperature.

Do not use under conditions where sudden change of water pressure occurs.

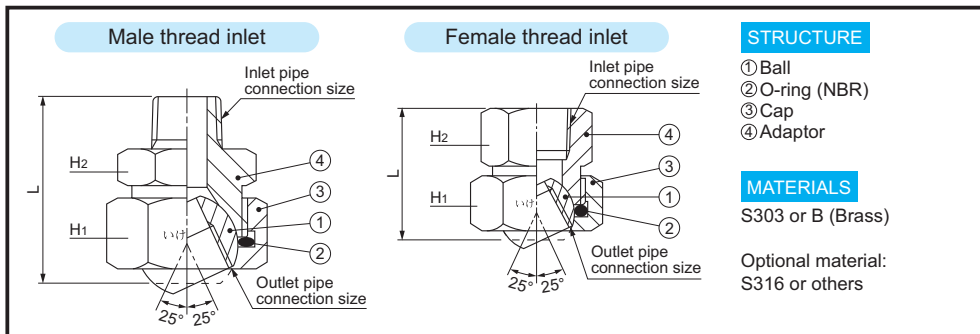

STRUCTURE

- 1 Ball
- 2 O-ring (NBR)
- 3 Cap
- 4 Adaptor

MATERIALS

S303 or B (Brass)

Optional material:
S316 or others

Ball joint code (Inlet x Outlet)	Inlet pipe connection size	Outlet pipe connection size	Dimensions (mm)			Mass (g)	
			L	H ₁ (WAF) ^{*1}	H ₂ (WAF) ^{*1}	S303	B
UT R1/8 x Rc1/8	R1/8	Rc1/8	32.5	22	21	56	60
UT R1/4 x Rc1/8	R1/4	Rc1/8	36.0	22	21	60	65
UT R1/4 x Rc1/4	R1/4	Rc1/4	39.5	29	24	100	110
UT R3/8 x Rc1/4	R3/8	Rc1/4	40.0	29	24	110	115
UT R3/8 x Rc3/8	R3/8	Rc3/8	47.5	35	30	190	205
UT R1/2 x Rc1/2	R1/2	Rc1/2	54.5	41	41	325	350
UT R3/4 x Rc3/4	R3/4	Rc3/4	61.5	50	46	490	525
UT Rc1/8 x Rc1/8	Rc1/8	Rc1/8	28.5	22	21	63	69
UT Rc1/4 x Rc1/8	Rc1/4	Rc1/8	28.5	22	21	58	63
UT Rc1/4 x Rc1/4	Rc1/4	Rc1/4	33.5	29	24	110	120
UT Rc3/8 x Rc1/4	Rc3/8	Rc1/4	33.5	29	24	100	110
UT Rc3/8 x Rc3/8	Rc3/8	Rc3/8	44.5	35	30	220	235
UT Rc1/2 x Rc1/2	Rc1/2	Rc1/2	48.5	41	41	375	405
UT Rc3/4 x Rc3/4	Rc3/4	Rc3/4	55.5	50	46	560	600

*1) WAF = width across flats

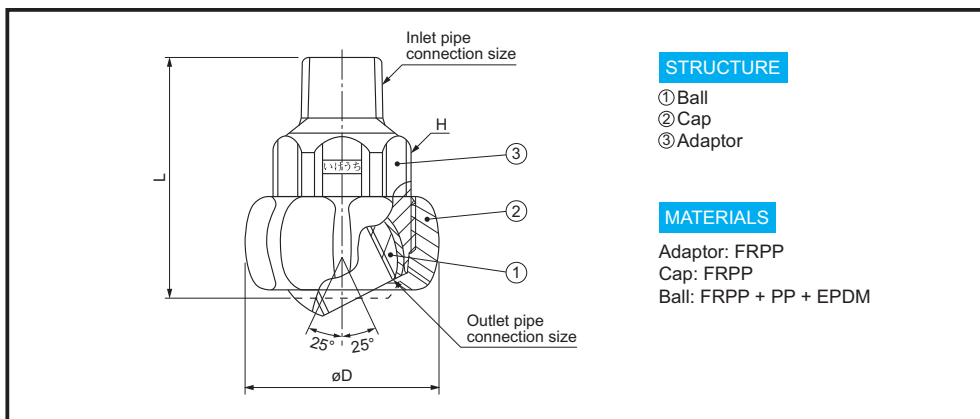

STRUCTURE

- 1 Ball
- 2 Cap
- 3 Adaptor

MATERIALS

Adaptor: FRPP
Cap: FRPP
Ball: FRPP + PP + EPDM

Ball joint code (Inlet x Outlet)	Inlet pipe connection size	Outlet pipe connection size	Dimensions (mm)			Mass (g)
			L	H	øD	
UT R1/8 x Rc1/8	R1/8	Rc1/8	38	21	32	12
UT R1/4 x Rc1/8	R1/4	Rc1/8	40	21	32	13
UT R1/4 x Rc1/4	R1/4	Rc1/4	40	21	32	12
UT R3/8 x Rc1/8	R3/8	Rc1/8	41	21	32	13
UT R3/8 x Rc1/4	R3/8	Rc1/4	41	21	32	12

How to order

Please inquire or order for a specific ball joint using this coding system.

Metal <Example> UT 1/8Mx1/8F S303

Plastic <Example> UT 1/8Mx1/8F FRPP-IN

UT	1/8M Inlet pipe conn. size ²	x	1/8F Outlet pipe conn. size ²	S303 Material
	<ul style="list-style-type: none"> ■ 1/8M ■ 1/4M ■ 3/8M ■ 1/2M ■ 3/4M 		<ul style="list-style-type: none"> ■ 1/8F ■ 1/4F ■ 3/8F ■ 1/2F ■ 3/4F 	<ul style="list-style-type: none"> ■ S303 ■ B

UT	1/8M Inlet pipe conn. size ²	x	1/8F Outlet pipe conn. size ²	FRPP-IN
	<ul style="list-style-type: none"> ■ 1/8M ■ 1/4M ■ 3/8M 		<ul style="list-style-type: none"> ■ 1/8F ■ 1/4F 	

*2) "M" indicates male thread ("R" of the ISO standard) and "F" indicates female thread ("Rc" of the ISO standard).

To order, please specify the pipe connection size by replacing respectively "R" and "Rc" by "M" and "F" as in the above chart.

WUT series 360° Rotatable Universal Joints



Photo is WUT Universal Joint with a spray nozzle.



FEATURES

- 360° rotatable to adjust spray direction.
- Includes the rotating lock to keep the nozzle direction fixed.
- Safe design prevents parts from dropping off when the lock is released.

WUT series

MATERIALS

Adaptor: SCS13
Bolt: S303
E-ring: S304
O-ring: NBR

MASS

146 g

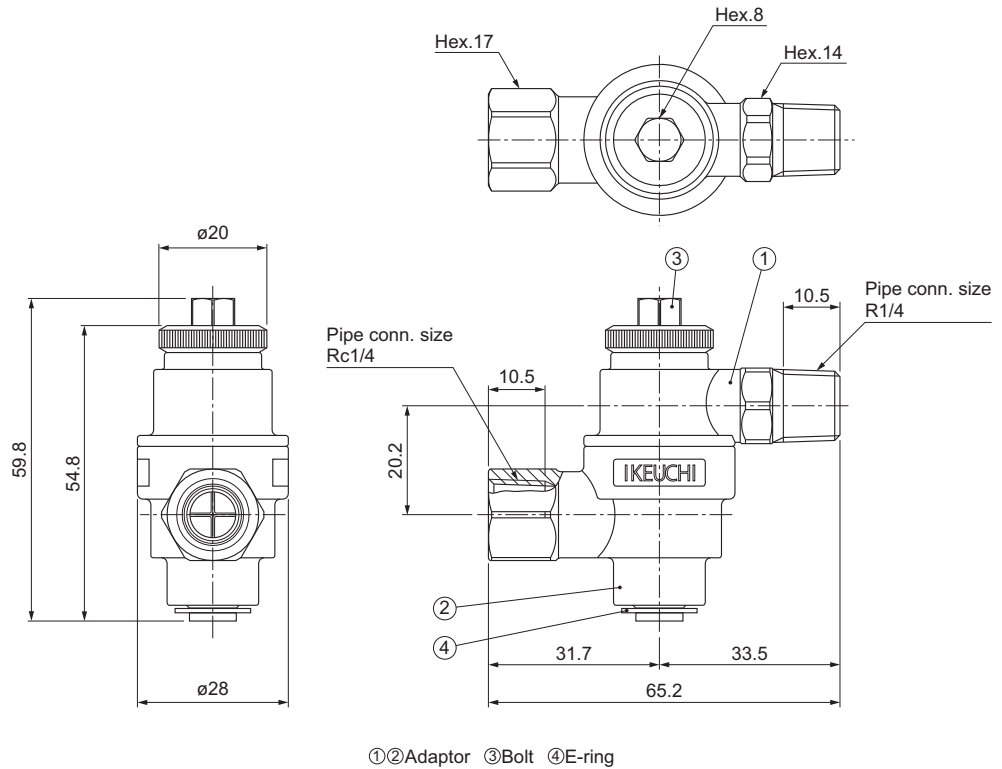

Cautions for use

- The bolt may loosen because of vibration if it is screwed in by hand. Tighten with a torque-wrench at 6 N·m.
- Maximum working pressure is 3 MPa.
- When used with a solid stream jet nozzle, slightly turbulent flow occurs.

How to order

Please inquire or order as below.

WUT 1/4M x 1/4F SCS13

ROTARY JETTER RJ series

Low-pressure Rotating Cleaning Nozzles

Rolling mill process

Versatile tank cleaning

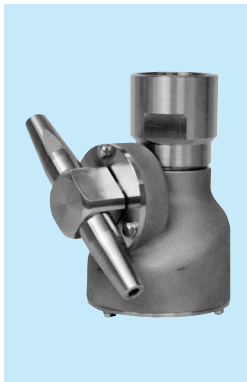

Use pressure		0.3–0.8 MPa
Spray capacity	Product code	
	RJ3-2-ø7	103 ℓ/min–169 ℓ/min (at 0.3 MPa) (at 0.8 MPa)
	RJ3-2-ø8	127 ℓ/min–207 ℓ/min (at 0.3 MPa) (at 0.8 MPa)
Reach distance		Approx. 10 m in radius
Heat resistance		80C°
Mass		2.7 kg
Material		S304

Buff finishing is possible as an extra-cost option. Please inquire with us. Four direction spray type is available on request.

FEATURES

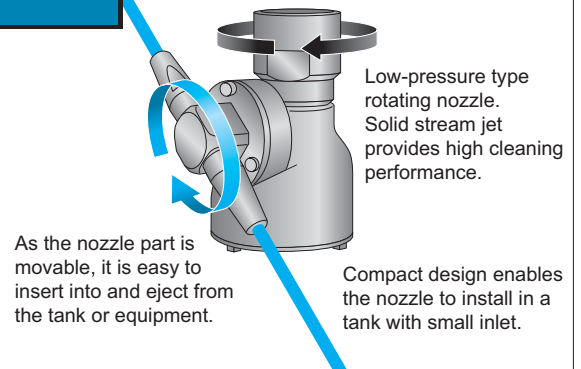

JET ATTACKER JA series

Rotating Nozzles for Tank Cleaning

Rolling mill process

Versatile tank cleaning

3-Dimensional type

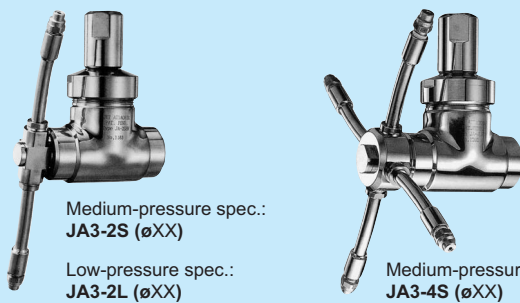

Nozzle orifice diameter is specified in place of XX.

FEATURES

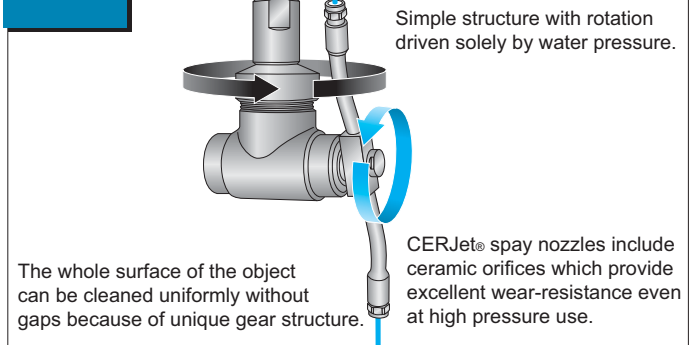

Product code	Number of nozzles equipped	Pipe connection size	Working pressure (MPa)	Spray capacity (ℓ/min)	Allowable temperature (°C)	Main materials	Mass (kg)
JA3-2L (øXX)	2	Rc1/2	0.3–1.2	24–82	4–60	S304, special PTFE, NBR, FKM	1.70
JA3-2S (øXX)	2		1.0–3.0	12–36			1.60
JA3-4S (øXX)	4		24–70	1.95			

Nozzle orifice diameter is specified in place of XX.

Conversion of unit [Pressure] 0.1 MPa ≈ 14.50 psi [Flow rate] 1 ℓ (liter) ≈ 0.26 US gal.
10 psi ≈ 0.07 MPa 1 US gal. ≈ 3.79 ℓ (liter)

2-Dimensional type

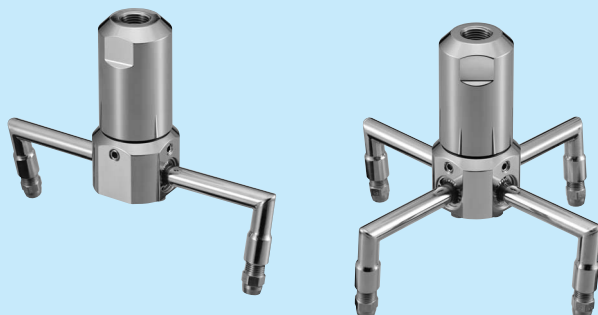

FEATURES

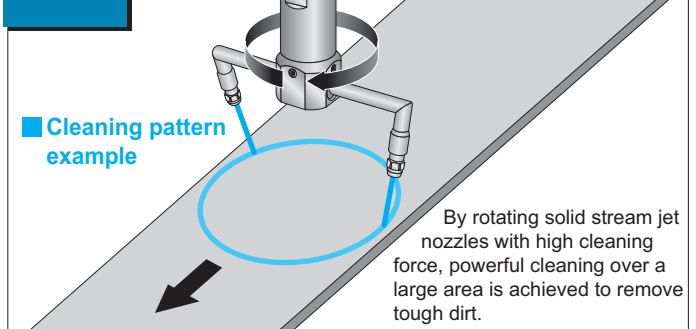

Product code	Number of nozzles equipped	Pipe connection size	Working pressure (MPa)	Spray capacity (ℓ/min)	Allowable temperature (°C)	Main materials	Mass (kg)
JA2-2 (øXX)	2	Rc1/2	0.3–3.0	14–53	4–60	S304, PTFE, NBR, FKM	1.9
JA2-4 (øXX)	4			28–98			2.0

Nozzle orifice diameter is specified in place of XX.

SR series Low-Speed Rotating Cleaning Nozzles

Rolling mill process ● Versatile tank cleaning

FEATURES

■ Spray pattern (360° spray)



Low-Speed Rotation

Low-speed rotation of 5–10 rpm*1 at 0.3 MPa. Maximized contact time between cleaning object and spray liquid achieves higher cleaning effect.

*1) Reference value

Heat-Resistant

Made of stainless steel 316L with high heat resistance.

Applications

Cleaning for tanks, containers, filling machines, conveyers and various other tanks.



Spray capacity code	Pipe conn. size	Spray capacity (ℓ/min) ²					Spray pattern	Rotation speed (rpm) ² (at 0.3 MPa)	Heat resistance
		0.15 MPa	0.3 MPa	0.5 MPa	0.7 MPa	1.0 MPa			
13	Rc1/8	9.19	13.0	16.8	19.9	23.7	Flat spray 360°	5–10	150°C
20	Rc1/4	14.1	20.0	26.0	30.6	36.5			
31	Rc3/8	21.9	31.0	40.0	47.4	56.6			
42	Rc3/8	29.7	42.0	54.2	64.2	76.7			
70	Rc1/2	49.5	70.0	90.4	107	128			
150	Rc3/4	106	150	194	229	274			

*2) Spray capacity and rotation speed are for reference only.

Note: 1) Use of strainer is recommended. Recommended strainer mesh size #200.

2) Install the nozzle downward for stable rotation.

3) If upward nozzle installation is needed, please use our ES series nozzles instead.

Conversion of unit [Pressure] 0.1 MPa ≈ 14.50 psi [Flow rate] 1 ℓ (liter) ≈ 0.26 US gal.
10 psi ≈ 0.07 MPa 1 US gal. ≈ 3.79 ℓ (liter)

How to order

Please inquire or order for a specific nozzle using this coding system.

*3) "M" indicates male thread (R) and "F" indicates female thread (Rc).

To order, please specify the pipe connection size by replacing respectively "R" and "Rc" by "M" and "F" as in the above chart.

<Example> 1/8F SR 13N S316L (360)

1/8F	SR	13	N S316L (360)
Pipe conn. size ³		Spray capacity code	
■ 1/8F ■ 1/2F		■ 13 ■ 42	
■ 1/4F ■ 3/4F		■ 20 ■ 70	
■ 3/8F		■ 31 ■ 150	

ES series Rotating Cleaning Nozzles for Tanks/Containers

Surface finish ● Cleaning for chemical tanks

FEATURES

Easy maintenance due to low number of parts.

Rotation is driven solely by the flow of the cleaning fluid even at low pressure of 0.05–1.0 MPa.

Rotating flat spray or solid stream pattern achieves a complete, uniform cleaning.

[Spray variations]

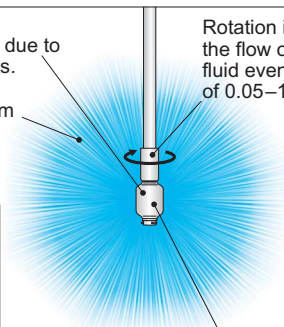
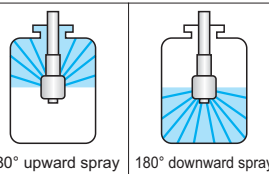

Compact design, minimum total length 38 mm.

Stainless steel type

PTFE type



Stainless steel ES series

Spray capacity code	Pipe conn. size	Spray capacity at 0.3 MPa (ℓ/min)	Dimensions (mm)	Mass (g)	Spray pattern
01	Rc1/8	7	ø16x38	20	360° 180° upward 180° downward
02	Rc1/8	13	ø20x53	35	
03	Rc1/4	20	ø25x65	75	
05	Rc3/8	31	ø30x97	155	
1	Rc3/8	42	ø31.5x115	185	
2	Rc1/2	70	ø41.5x123	260	
3	Rc3/4	150	ø60x139	605	
4	Rc1	210	ø75x163	925	
5	Rc1*1/2	440	ø88x180	1,640	

Max. allowable temperature for ES series, stainless steel type is 60°C (140°F).

PTFE ES/ESV series

Spray capacity code	Pipe conn. size	Spray capacity at 0.3 MPa (ℓ/min)	Dimensions (mm)	Mass (g)	Spray pattern
30	Rc1/2	30	ø50x65	130	360° 180° upward 180° downward (ESV: Flat spray, 360° only)
40		40			
70	Rc3/4	70	ø57x75	180	
150		150			

Spray capacity code of 110 (110 ℓ/min. at 0.3 MPa) is available in **ESV-PTFE** series. Max. allowable temperature for ES/ESV-PTFE series is 93°C (199°F).

Conversion of unit [Pressure] 0.1 MPa ≈ 14.50 psi [Flow rate] 1 ℓ (liter) ≈ 0.26 US gal.
10 psi ≈ 0.07 MPa 1 US gal. ≈ 3.79 ℓ (liter)

For details of the rotating nozzles for tank/container cleaning, please ask for each product leaflets.

CLJ series COOLJetter Cooling Fan Unit with Semi-Dry Fog® Nozzles

Improve work environment

- Environment cooling (heat reduction)
- Spot cooling of heated refractories and steel products
- Dust suppression
- Spraying of deodorizer

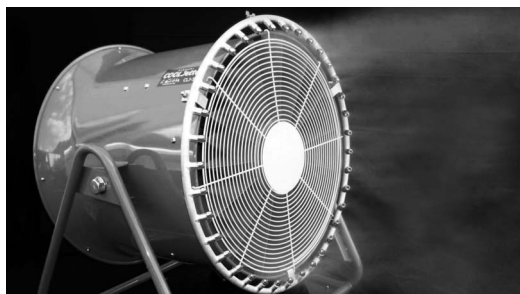



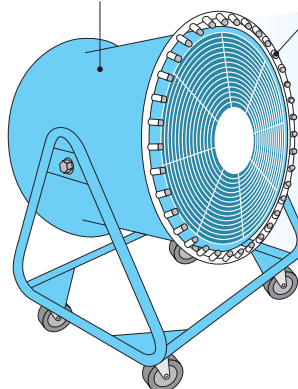

FEATURES

Energy-economizing unit cools outdoor and semi-enclosed spaces at low cost.

Equipped with LYOHM nozzles spraying 10–30 μm Semi-Dry Fog®.



High-capacity fan allows fog cooling over a wide area of 5–50 m.

Product code (CLJ-)	Dimensions		Mass (kg)	Number of nozzles equipped (pcs.)	Spray capacity (ℓ/hr)	Fan ventilation (m³/min) (50/60 Hz)	Power supply	Main features, accessories
	Fan diameter (mm)	Width x Depth x Height (mm)					Power consumption	
 S-E	ø450	840 x 740 x 1,170–1,280	15 (w/o water)	6	6.4 (at 1.3 MPa)	165/186	100 VAC 160 W (50 Hz) 200 W (60 Hz)	<ul style="list-style-type: none"> • No installation work • Low water level sensor • 75-degree oscillation
 CSA-F	ø450	575 x 1,020 x 1,320–1,400	46 (w/o water)	6	14.2 (at 6 MPa)	165/186	327 W (50 Hz) 394 W (60 Hz)	<ul style="list-style-type: none"> • No installation work • Low water level sensor • 75-degree oscillation • w/ Mobile cart <p>Optional Tap water direct connection</p>
 300-KU ^{*1}	ø300	420 x 410 x 930	12	8	13.6 (at 3 MPa) 18.9 (at 6 MPa)	79/87	100 VAC 68 W (50 Hz) 96 W (60 Hz)	<ul style="list-style-type: none"> • Quiet sound • Adjustable elevation angle (max. 30°) • 60-degree oscillation
 590D-K ^{*1 *3}	ø590	800 x 680 x 1,010	70	36	57.2 (at 3 MPa) 85.0 (at 6 MPa)	320/320	200 VAC (3-phase) 1,500 W (50 Hz) 1,900 W (60 Hz)	<ul style="list-style-type: none"> • Dust-/Water-proof (IP55 equivalent)^{*3} • Adjustable elevation angle (max. 90°) • w/ Wheels <p>Optional^{*2} Oscillation (3 levels, max. 45°)</p>
 C590A	ø590	1,250 x 990 x 1,360	200	24	56.6 (at 6 MPa)	320/320	200 VAC (3-phase) 1,900 W (50 Hz) 2,300 W (60 Hz)	<ul style="list-style-type: none"> • No installation work • w/ Mobile cart • Adjustable elevation angle (max. 90°)

Note:

*1) Pump unit (sold separately) is required for use.

*2) Shape of the CLJ-590D-K fan base (foot) differs with or without optional features.

*3) Product code for CLJ-590D-K with the optional oscillation function is CLJ-590-KU, IP44 equivalent.

CLJ series
COOLJetter® Cooling Fan Unit with Semi-Dry Fog® Nozzles

Examples of COOLJetter® in use

Cooling in factories



Dust suppression



Pump units for CLJ series



Product code	Dimensions*4	Mass (kg)	Max. pressure (MPa)	Max. discharge volume (ℓ/hr) (50/60 Hz)	Power supply	Motor capacity	Accessories and features
	Width x Depth x Height (mm)						
YBK13-05IK	270 x 430 x 270	12	6	21/24	100 VAC	125 W	<ul style="list-style-type: none"> • Pressure gauge • Water tank (1 ℓ) with ball tap • Water filter (100 μm) ★ Pump & motor direct connection type
KYZ40E-2IK	435 x 735 x 550	55		77/93	100 VAC or 200 VAC (3-phase)	400 W	<ul style="list-style-type: none"> • Pressure gauge • Water tank (11 ℓ) with ball tap • Low water level sensor • Time integrator
KYZ75E-4IK	435 x 755 x 550	60		195/236		750 W	<ul style="list-style-type: none"> • Time integrator
KYZ150E-9IK	435 x 770 x 550	65		414/500		1,500 W	★ Pump & motor belt connection type
KYZ220E-13IK	485 x 820 x 605	70		586/708	200 VAC (3-phase)	2,200 W	<ul style="list-style-type: none"> • Pressure gauge • Water tank (15 ℓ) with ball tap • Low water level sensor • Time integrator ★ Pump & motor belt connection type

*4) Please inquire with us for detail dimensions.

Note: The pumps in the photos may differ from the actual products.

Please inquire with us for details.

ARS series Auto Reverse Self-cleaning Filter

All process

- Recycling of drainage water after cleaning
- Industrial water filtration, cooling water filtration

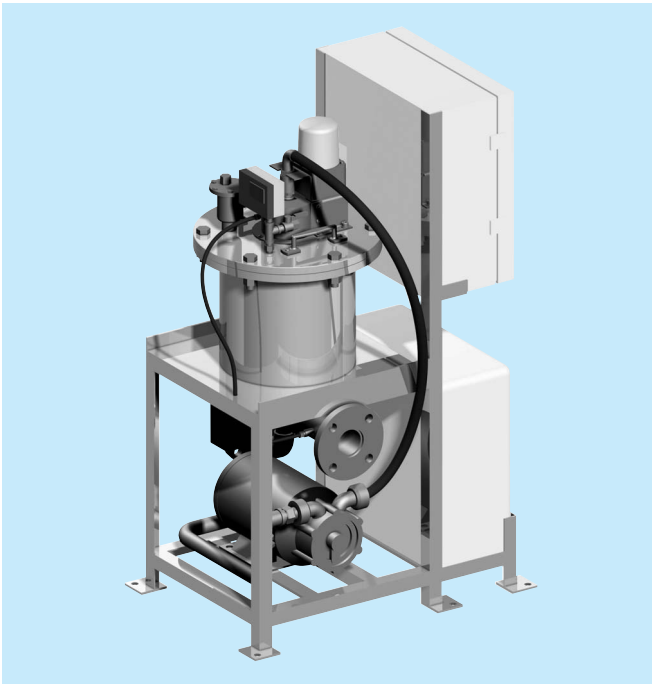

Installation example

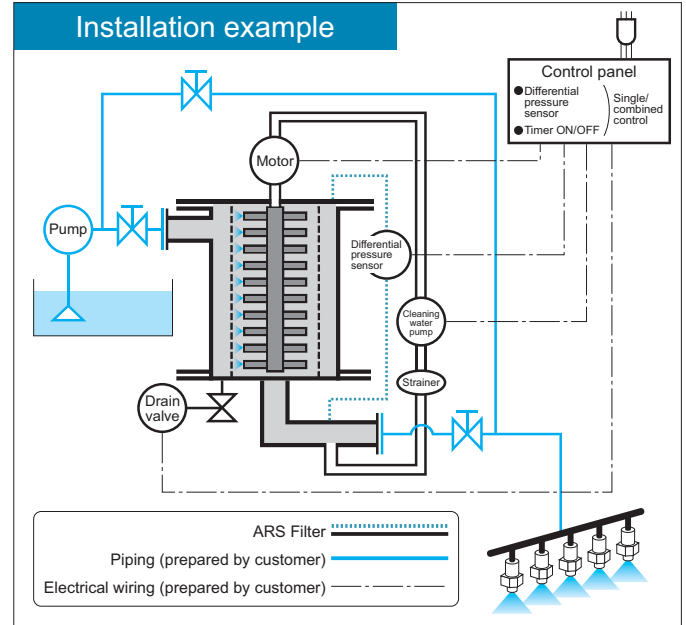

- ARS Filter employs a high-pressure jet spray backwashing method. It ensures stable cleaning, without requiring consumable parts such as cleaning brushes.
- Compact design to install in a small space.
- Detecting the pressure difference caused by an accumulation of foreign particles on the filter, ARS starts jet spray cleaning automatically and discharges foreign particles through the drain.

SPECIFICATIONS

Product code	ARS-150	ARS-500	ARS-1000	ARS-2500
Max. filtration capacity (ℓ/min)	150	500	1,000	2,500
Max. allowable pressure (MPa)	1.0	1.0	1.0	1.0
Power supply, Power consumption	100 VAC, 0.3 kW*	200 VAC (3-phase), 1.7 kW	200 VAC (3-phase), 2.5 kW	200 VAC (3-phase), 3.8 kW
Pipe connection size	Inlet	32 A	50 A	80 A
	Outlet	32 A	50 A	80 A
	Drain	25 A	25 A	40 A
Filter screen type	Metal wire	#300, #150, #100, #60, #35	#150, #100, #60, #35	#150, #100, #60, #35
	Wedge wire	—	100 μm, 150 μm, 300 μm, 500 μm	100 μm, 150 μm, 300 μm, 500 μm
Dimensions (Width x Depth x Height) [mm]	360 x 510 x 1,300	433 x 666 x 1,053	560 x 1,000 x 1,223	1,000 x 1,800 x 1,882
Mass (without water) [kg]	67*	115	175	850

*Value for ARS-150 with iron pump.

MATERIALS

Body: Stainless steel (Note: Not all wetted surfaces of cleaning pump and its hoses are stainless steel)

Packing, O-ring: FKM

ARS Filter used in recycling of industrial water for cooling steel plates

Nozzles became clogged due to foreign particles in the industrial water.



After ARS Filter is installed...

Results: Stable production and stable operation

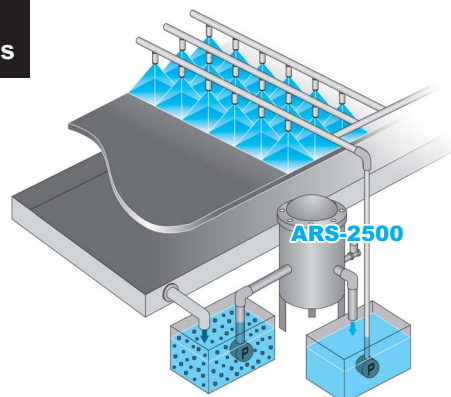

- Liquid: Industrial water
- Foreign particles: Algae, sand, etc.
- Screen mesh size: 100 μm, 300 μm
- Type of screen: Wedge wire

For details, please refer to our ARS Filter catalog and leaflet.



いけうち

“The Fog Engineers”
H. IKEUCHI & CO., LTD.



ISO9001 : 2008 certified
 (H. IKEUCHI & CO., LTD., Japan only)

Headquarters

Daiichi Kyogyo Bldg., 1-15-15, Awaza, Nishi-ku, Osaka 550-0011, Japan
 Tel: 81-6-6538-4015 Fax: 81-6-6538-4022
 overseas@kirinoikeuchi.co.jp <https://www.kirinoikeuchi.co.jp/eng/>

Overseas network

IKEUCHI USA, INC.

8110 Beckett Center Drive, West Chester OH 45069, USA
 Tel: 1-513-942-3060 Fax: 1-513-942-3064
 info@ikeuchiusa.com
<http://www.ikeuchiusa.com/>

Georgia Office Tel: 1-706-850-3332 Fax: 1-706-850-3309

IKEUCHI EUROPE B.V.

Asterweg 17 A6, 1031 HL Amsterdam, The Netherlands
 Tel: 31-20-820-2175 Fax: 31-20-820-2176
 info@ikeuchieurope.com
<http://www.ikeuchieurope.com/>

IKEUCHI (SHANGHAI) CO., LTD.

Room C, 21/F, Electrical & Mechanical Bldg.,
 600 Hengfeng Road, Shanghai 200070, P.R.China
 Tel: 86-21-6140-9731 Fax: 86-21-6123-4239
 mist@kirinoikeuchi.com (for Shanghai, Tianjin, Shenzhen offices)
<http://www.kirinoikeuchi.com/>

Tianjin Branch Tel: 86-22-2320-1676 Fax: 86-22-2320-1675

Shenzhen Branch Tel: 86-755-8525-2221 Fax: 86-755-8525-2215

PT. IKEUCHI INDONESIA

Ruko Easton Jalan Gunung Panderman Blok E No.9,
 Lippo Cikarang Kel. Cibatu Kec., Cikarang Selatan Bekasi 17550
 Indonesia
 Tel: 62-21-2909-3246 Fax: 62-21-2909-3247
 sales@ikeuchi.co.id
<http://www.kirinoikeuchi.co.jp/ijk/>

IKEUCHI TAIWAN CO., LTD.

11F-1, No. 27, Sec. 1, Chung Shan N. Rd., Taipei Taiwan, R.O.C.
 Tel: 886-2-2511-6289 Fax: 886-2-2541-6392
 sales@ikeuchi.com.tw
<http://www.ikeuchi.com.tw/>

